

Introduction to Phasors

Ken Kundert

Designer's Guide Consulting, Inc.

Version 1b, 21 September 2011 This paper gives an introduction to phasors and AC small-signal analysis with an emphasis on demonstrating how one can quickly understand the behavior of simple AC circuits without detailed calculations by examining the circuit and using high level reasoning.

Last updated on September 23, 2011. You can find the most recent version at www.designers-guide.org. Contact the author via e-mail at ken@designers-guide.com.

Permission to make copies, either paper or electronic, of this work for personal or classroom use is granted without fee provided that the copies are not made or distributed for profit or commercial advantage and that the copies are complete and unmodified. To distribute otherwise, to publish, to post on servers, or to distribute to lists, requires prior written permission.

Contents

1. Introduction	2
2. Phasors	3
3. Phasor Model of a Resistor	4
4. Phasor Model of a Capacitor	4
5. Phasor Model of an Inductor	5
6. Impedance and Admittance	5
7. DC	7
8. Visualizing Impedance and Admittance	7
9. Voltage and Current Dividers	14
10. Simple Filters	17
11. Simple Active Filters	19
12. Conclusion	20
12.1. If You Have Questions	21
Appendix A. Immittance Charts	21

1 Introduction

Phasor analysis allows you to determine the steady-state response to a linear circuit driven by sinusoidal sources with frequency f . This is something that is very common. For example, one can use phasor analysis to characterize the frequency response of a circuit by performing phasor analysis over a range of frequencies. To understand what phasor analysis is, let's parse this statement carefully. The statement consists of three parts:

1. Phasor analysis determines the steady-state response ...
2. ... to a linear circuit ...
3. ... driven by sinusoidal sources with frequency f .

The first part of this statement assumes that we wait for the steady-state response, meaning that we are assuming that the circuit is stable so any transient behavior dies away over time the response becomes completely repetitive. With this statement we are assuming that we have waited for that initial transient behavior to disappear. In other words, phasor analysis computes only the steady-state behavior. The second part assumes that the circuit is linear. This means that the circuit is constructed from linear components[†], such as simple resistors, capacitors and inductors. Nonlinear components such as transistors are specifically excluded[‡]. The third part is the assumption that all

[†]. A linear component is one whose response is proportional to its input. For example, a resistor is linear if $V=IR$ because voltage V , the response, is proportional to I , the input with the constant of proportionality being R . Notice that if you double I the resistor will respond by doubling V . An example of a nonlinear component is a diode, where $I = I_s e^{V/V_t - 1}$. In this case the output (the current I) is not proportional to the input (the voltage V). Specifically, doubling V more than doubles I .

[‡]. If your circuit includes transistors or other nonlinear components, all is not lost. There is an extension of phasor analysis to nonlinear circuits called small-signal analysis in which you linearize the components before performing phasor analysis. This is the basis of the AC analyses of SPICE. Furthermore, the transistors may be combined into a circuit that in composite can be treated as linear, such as if the transistors take the form of an op-amp.

the sources in the circuit are purely sinusoidal with the same frequency f . It turns out that this assumption is not much of a restriction given the other assumptions we have already made. With the circuit being linear, if two frequencies are present simultaneously they can be handled separately because of superposition (if there are two frequencies present, f_1 and f_2 , then when computing the response at f_1 you can completely ignore the signals at f_2 and visa versa). Furthermore, with the assumption of steady state, if a source is not producing a sinusoidal value, we can always use Fourier analysis to decompose it into a collection of sinusoids at different frequencies [3]. Then using superposition, we can analyze the circuit at each frequency separately.

It is possible to use phasor analysis to analyze arbitrarily complex linear circuits. However in this introduction a simplified analysis is presented that starts by presenting the basic phasor models for resistors, capacitors, and inductors, and then build up to models of simple series and parallel combinations of these components. Then, a graphical interpretation can give you a pretty good understanding of a simple RLC circuit quickly.

2 Phasors

A sinusoid is characterized by 3 numbers, its amplitude, its phase, and its frequency. For example,

$$v(t) = A \cos(\omega t + \phi) \quad (1)$$

Here A is the amplitude, ϕ is the phase, and f is the frequency, where $\omega = 2\pi f$. In a circuit there will be many signals but in the case of phasor analysis they will all have the same frequency. For this reason, the signals are characterized using only their amplitude and phase. The combination of an amplitude and phase to describe a signal is the phasor for that signal. Thus, the phasor for the signal in (1) is $A \angle \phi$.

In general phasors are functions of the frequency ω , and so it would be more appropriate to refer to the amplitude and phase of the phasor using $A(\omega)$ and $\phi(\omega)$, but this formalism will be neglected so that the equations presented appear less cluttered. But you should always keep in mind that in general, phasors are functions of frequency.

Often it is preferable to represent a phasor using complex numbers rather than using amplitude and phase. In this case we represent the signal as:

$$v(t) = \Re \{ V e^{j\omega t} \} \quad (2)$$

where V is a complex number, \Re returns the real part of its argument and $j = \sqrt{-1}$. In this case V is the phasor. It can either be given in rectangular or polar form, so either $V = V_R + jV_I = A e^{j\phi}$. To see that (1) and (2) are the same, remember Euler's formula, which says that

$$e^{j\theta} = \cos \theta + j \sin \theta.$$

Then, from (2)

$$v(t) = \Re \{ V e^{j\omega t} \} \quad (3)$$

$$v(t) = \Re \{ A e^{j\phi} e^{j\omega t} \} \quad (4)$$

$$v(t) = \Re \{ A e^{j(\omega t + \phi)} \} \quad (5)$$

$$v(t) = \Re \{ A \cos(\omega t + \phi) + j \sin(\omega t + \phi) \} \quad (6)$$

$$v(t) = A \cos(\omega t + \phi). \quad (7)$$

3 Phasor Model of a Resistor

A linear resistor is defined by the equation:

$$v = Ri.$$

Now, assume that the resistor current is described with the phasor I . Then

$$i(t) = \Re \{ I e^{j\omega t} \}. \quad (8)$$

R is a real constant, and so the voltage can be computed to be

$$v(t) = R \Re \{ I e^{j\omega t} \} = \Re \{ R I e^{j\omega t} \}. \quad (9)$$

The phasor representation for v is

$$v(t) = \Re \{ V e^{j\omega t} \}. \quad (10)$$

Now we can see by inspection that for a resistor,

$$V = RI. \quad (11)$$

Thus, given the phasor for the current we can directly compute the phasor for the voltage across the resistor. Similarly, given the phasor for the voltage across a resistor we can compute the phasor for the current through the resistor using:

$$I = \frac{V}{R}. \quad (12)$$

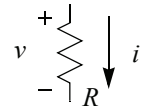

4 Phasor Model of a Capacitor

A linear capacitor is defined by the equation:

$$i = C \frac{dv}{dt}.$$

Now, assume that the voltage across the capacitor is described with the phasor V . Then

$$v(t) = \Re \{ V e^{j\omega t} \}. \quad (13)$$

C is a real constant, and so the current through the capacitor can be computed to be

$$i(t) = C \Re \left\{ \frac{d}{dt} V e^{j\omega t} \right\} = \Re \{ j\omega C V e^{j\omega t} \}. \quad (14)$$

The phasor representation for i is

$$i(t) = \Re \{ I e^{j\omega t} \}. \quad (15)$$

Now we can see by inspection that for a resistor,

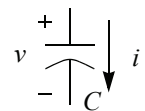

$$I = j\omega CV. \quad (16)$$

Thus, given the phasor for the voltage across a capacitor we can directly compute the phasor for the current through the capacitor. Similarly, given the phasor for the current through a capacitor we can compute the phasor for the voltage across the capacitor using:

$$V = \frac{I}{j\omega C}. \quad (17)$$

5 Phasor Model of an Inductor

A linear inductor is defined by the equation:

$$v = L \frac{di}{dt}.$$

Now, assume that the inductor current is described with the phasor I . Then

$$i(t) = \Re\{Ie^{j\omega t}\}. \quad (18)$$

L is a real constant, and so the voltage can be computed to be

$$v(t) = L \Re\left\{\frac{d}{dt}Ie^{j\omega t}\right\} = \Re\{j\omega LIe^{j\omega t}\}. \quad (19)$$

The phasor representation for v is

$$v(t) = \Re\{Ve^{j\omega t}\}. \quad (20)$$

Now we can see by inspection that for an inductor,

$$V = j\omega LI. \quad (21)$$

Thus, given the phasor for the current we can directly compute the phasor for the voltage across the inductor. Similarly, given the phasor for the voltage across an inductor we can compute the phasor for the current through the inductor using:

$$I = \frac{V}{j\omega L}. \quad (22)$$

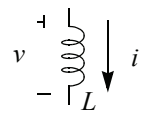

6 Impedance and Admittance

For a linear component, impedance is defined to be the ratio of the phasor for the voltage across the component and the current through the component:

$$Z = \frac{V}{I}. \quad (23)$$

Impedance is a complex value. The real part of the impedance is referred to as the resistance (denoted R) and the imaginary part is referred to as the reactance (denoted X). Thus,

$$Z = R + jX. \quad (24)$$

For a linear component, admittance is defined to be the ratio of the phasor for the current through the component and the voltage across the component:

$$Y = \frac{I}{V}. \quad (25)$$

Admittance is a complex value. The real part of the admittance is referred to as the conductance (denoted G) and the imaginary part is referred to as the susceptance (denoted B). Thus,

$$Y = G + jB. \quad (26)$$

Impedance is the reciprocal of admittance,

$$Z = \frac{1}{Y}. \quad (27)$$

From (11) and (12) the impedance and admittance of a resistor is:

$$Z = \frac{V}{I} = R, \text{ and} \quad (28)$$

$$Y = \frac{I}{V} = \frac{1}{R}. \quad (29)$$

From (16) and (17) the impedance and admittance of a capacitor is:

$$Z = \frac{V}{I} = \frac{1}{j\omega C}, \text{ and} \quad (30)$$

$$Y = \frac{I}{V} = j\omega C. \quad (31)$$

From (21) and (22) the impedance and admittance of an inductor is:

$$Z = \frac{V}{I} = j\omega L, \text{ and} \quad (32)$$

$$Y = \frac{I}{V} = \frac{1}{j\omega L}. \quad (33)$$

Impedance and admittance are generalizations of resistance and conductance. They differ from resistance and conductance in that they are complex and they vary with frequency, but they can be treated in similar ways. For example, the resistance of two components combined in series is simply the sum of the resistance for each component. The same is true for impedance, as shown in Figure 1.

$$Z = \frac{V}{I} = \frac{V_1 + V_2}{I} = Z_1 + Z_2. \quad (34)$$

The admittance of two series admittances is the reciprocal of the sum of the reciprocals of the admittance of each branch.

$$Y = \frac{1}{Z} = \frac{1}{Z_1 + Z_2} = \frac{1}{\frac{1}{Y_1} + \frac{1}{Y_2}}. \quad (35)$$

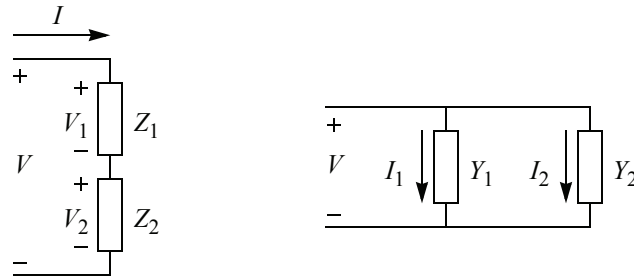
FIGURE 1 *Series and shunt combinations.*

Similarly, the admittance of two components combined in shunt is simply the sum of the admittance for each component, which is also illustrated in Figure 1.

$$Y = \frac{I}{V} = \frac{I_1 + I_2}{V} = Y_1 + Y_2. \quad (36)$$

The impedance of two shunt impedances is the reciprocal of the sum of the reciprocals of the impedance of each branch.

$$Z = \frac{1}{Y} = \frac{1}{Y_1 + Y_2} = \frac{1}{\frac{1}{Z_1} + \frac{1}{Z_2}}. \quad (37)$$

Going forward any statements we make about impedance are also likely to be true after appropriate modifications have been made about admittance. To avoid always having to refer to both, a new term, immittance, will be used to refer to both impedance and admittance.

7 DC

DC (direct current) is used to refer to the situation when the frequency of our sinusoids is 0. From (30) and (31) the impedance of a capacitor at DC is infinite and its admittance is 0. Thus, when analyzing a circuit at DC you can simply ignore the capacitors. You would do so by replacing them with open circuits. From (32) and (33) the impedance of an inductor at DC is 0 and its admittance is infinite. Thus, when analyzing a circuit at DC you can simply ignore the inductors as well, but in this case you ignore them by replacing them with short circuits.

8 Visualizing Impedance and Admittance

Visualizing the immittance (impedance or admittance) versus frequency for simple serial and parallel combinations of resistors, capacitors, and inductors is a very useful skill that allows you to examine many circuits and quickly understand their behavior. Fortunately, this is relatively easily done because the immittance of resistors, capacitors, and inductors is a straight line with a slope of 0, +1 or -1 when plotted on a log-log plot versus frequency. The immittance of a resistor always has a slope of 0 and the immittance of capacitors and inductors always has a slope of +1 or -1.

Consider a $1\text{k}\Omega$ resistor and a 1nF capacitor. The impedance of both are shown in Figure 2. Figure 3 shows the impedance of both a series and shunt combination of the

FIGURE 2 *The impedance of a $1\text{k}\Omega$ resistor and a 1nF capacitor.*

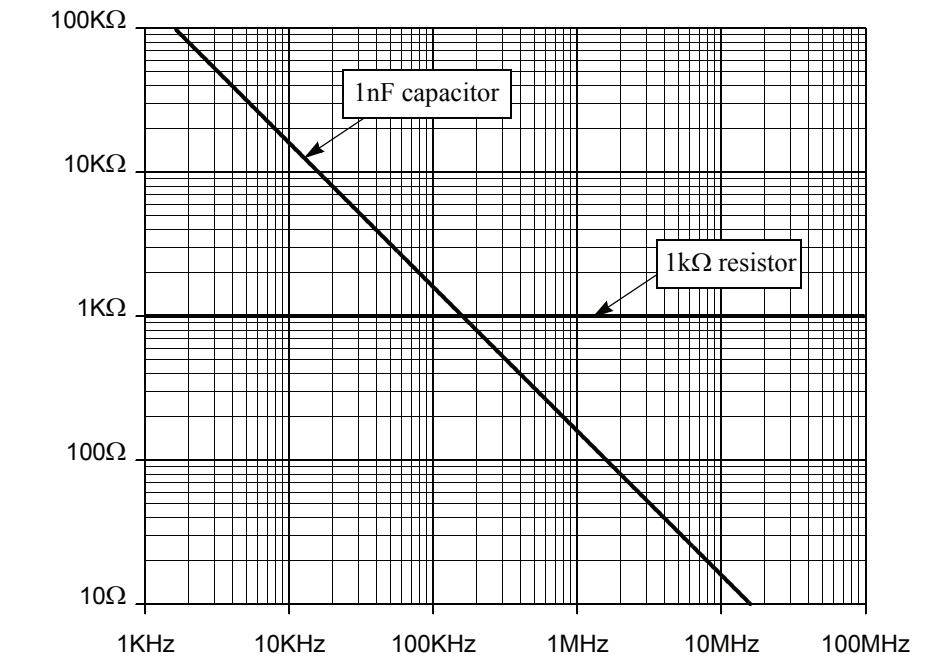

same $1\text{k}\Omega$ resistor and a 1nF capacitor.

Consider the series combination. From (34) the impedance of the combination is the sum of the impedances of the capacitor and the resistor. At low frequencies the sum is dominated by the impedance of the capacitor because it goes to infinity as frequency decreases. Thus, below the corner frequency, the impedance of the sum asymptotically approaches that of the capacitor. At high frequencies the impedance of the combination is dominated by that of the resistor because the impedance of the capacitor goes to zero as frequency increases. Thus, the impedance of the combination asymptotically approaches that of the resistor as frequency increases above the corner frequency. The corner frequency is that frequency where the magnitude of the impedances of the resistor and capacitor are equal. From (12), (17), and (23) that is:

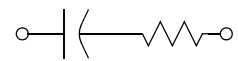

$$R = \frac{1}{2\pi f_c C}, \text{ or} \quad (38)$$

$$f_c = \frac{1}{2\pi RC}. \quad (39)$$

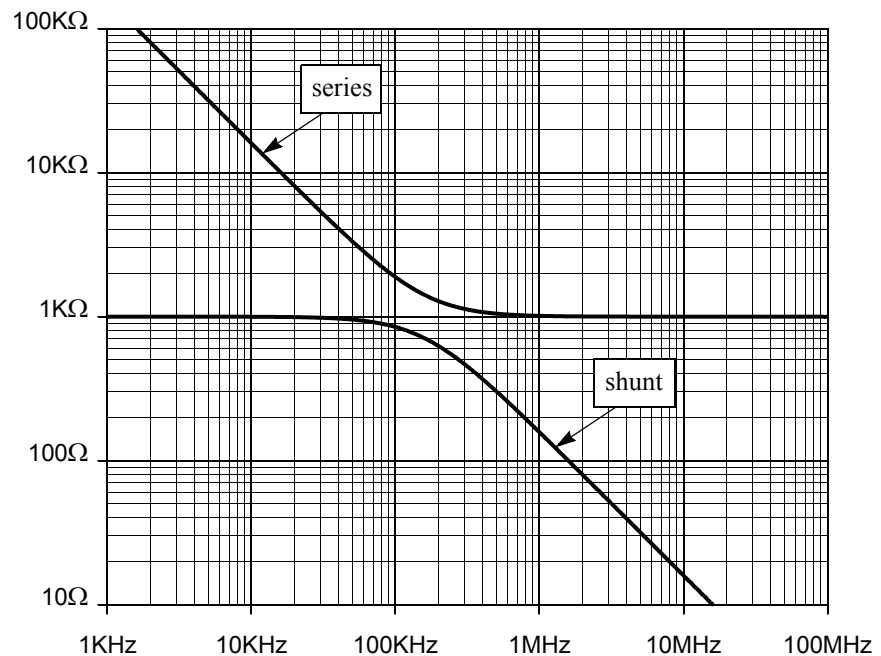
FIGURE 3 *The series and shunt combinations of 1kΩ resistor and a 1nF capacitor.*

The situation is similar for the shunt combination, except that at low frequencies the impedance is dominated by the resistor (most of the current will go through the resistor at low frequencies) and at high frequencies the impedance is dominated by the capacitor. The corner frequency is the same as above, except below the corner frequency the impedance of the combination asymptotically approaches that of the resistor and above the corner frequency it asymptotically approaches that of the capacitor.

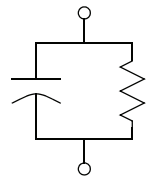

In the impedance of a series combination the component with the larger impedance dominates, in a shunt combination it is the component with the smallest impedance that dominates.

To plot the impedance of a resistor on a log-log plot such as in Figure 2 is easy because the impedance follows a grid line. It could also be easy to plot the impedance of a capacitor if the log-log grid is overlaid with a capacitance grid as shown in Figure 4. Notice how the impedance of the series combination follows the 1nF capacitance line below the corner frequency and the impedance of the shunt combination follows this same line above the corner frequency.

The same kind of analysis can be performed for inductors and resistors. The impedance of the series and shunt combinations of a 1kΩ resistor and 100μH inductor is shown in Figure 5. Notice that an inductance overlay was added to the graph. As before the corner frequency is where the magnitude of the impedance of the two components is the same. From (12), (22), and (23) that is:

$$R = 2\pi f_c L, \text{ or} \quad (40)$$

FIGURE 4 Impedance chart with a capacitance overlay.

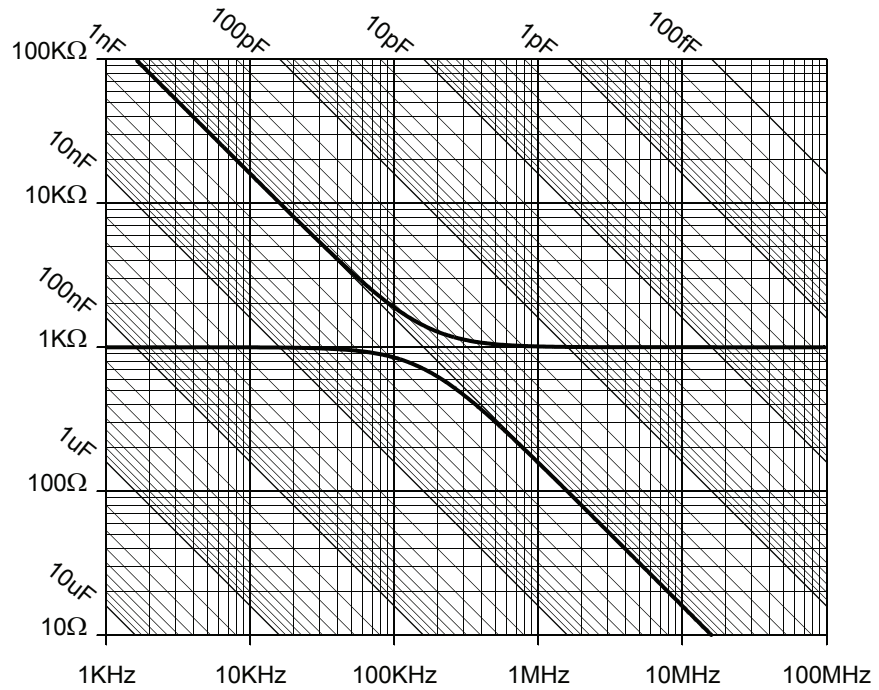
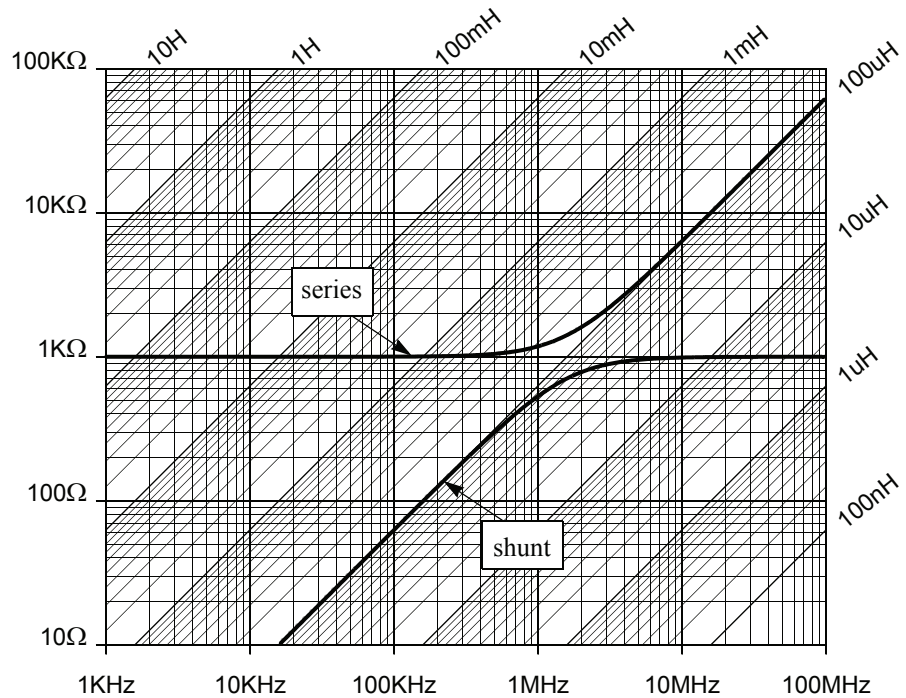

FIGURE 5 The series and shunt combinations of 1kΩ resistor and a 100μH.



$$f_c = \frac{R}{2\pi L} \tag{41}$$

Finally, consider the combination of all three types of components. Figure 6 shows the impedance of the series combination of a 500μH inductor, a 500pF capacitor, and 50Ω resistor. The graph shows both a capacitance and inductance overlay. Using these overlays it is easy to see that the impedance of the inductor alone will equal the impedance of the capacitor alone (when plotted alone, the graphs of their impedances will cross) at 300kHz, at which frequency both will be expected to have an impedance magnitude of 1kΩ. This is considerably larger than the resistance of the resistor, so it seems like the impedance of the capacitor and inductor should always dominate over that of the resistor in this case, making it unimportant. However, something very interesting happens at this frequency. To see what, let's be more careful about computing this corner frequency.



FIGURE 6 The series combination of a 500μH inductor, a 500pF capacitor, and 50Ω resistor.

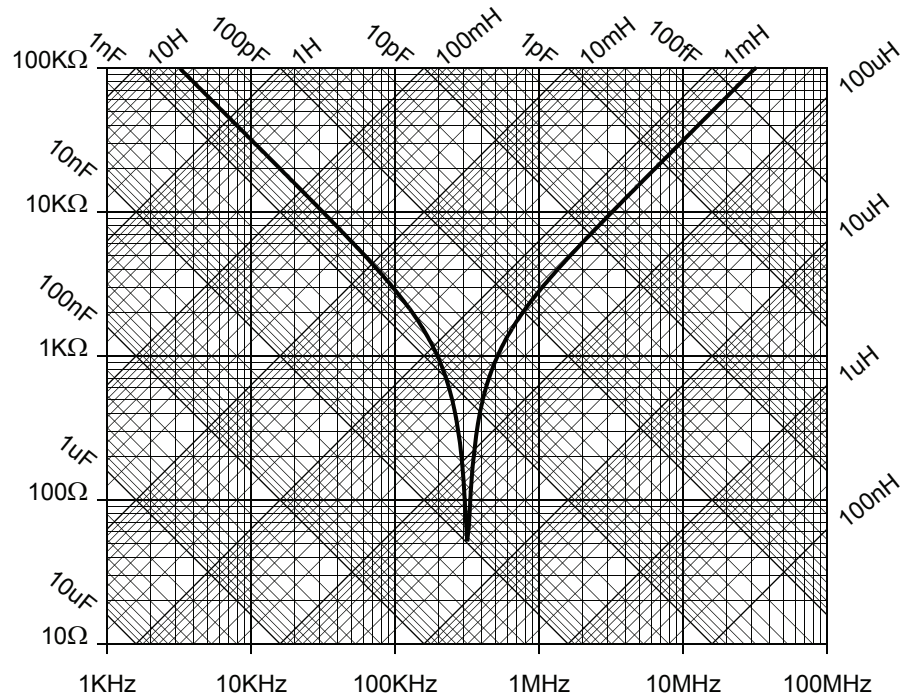

$$|Z_L| = |Z_C| \tag{42}$$

$$2\pi fL = \frac{1}{2\pi fC} \tag{43}$$

$$f = \frac{1}{2\pi\sqrt{LC}} \tag{44}$$

Now, let's carefully determine the impedance each exhibits at this frequency. From (21)

$$Z_L = j2\pi fL = j\sqrt{\frac{L}{C}}, \quad (45)$$

and from (17)

$$Z_C = \frac{1}{j2\pi fC} = -j\sqrt{\frac{L}{C}}, \quad (46)$$

So at this frequency, the impedance of the inductor and capacitor are equal in magnitude but opposite in sign. The total impedance of the series combination is:

$$Z = Z_L + Z_C + Z_R = j\sqrt{\frac{L}{C}} - j\sqrt{\frac{L}{C}} + 50 = 50. \quad (47)$$

Thus, imaginary parts of the impedance completely cancel at this frequency, and all that remains is the real portion, in this case, the resistance of the resistor. This cancellation is referred to as resonance, and in this case,

$$f_o = \frac{1}{2\pi\sqrt{LC}}. \quad (48)$$

is the resonant frequency of the circuit (in this case $f_o = 318.3\text{kHz}$). You can see that the cancellation causes a null to occur in the impedance at the resonant frequency. The depth of this null is referred to as the quality factor, or Q , of the resonance. The Q is defined as the ratio of the magnitude of the impedance of either the capacitor or inductor at the resonant frequency (they will be equal) to that of the resistance. This is illustrated in Figure 7. Thus,

FIGURE 7 The series combination of a $500\mu\text{H}$ inductor, a 500pF capacitor, and 50Ω resistor.

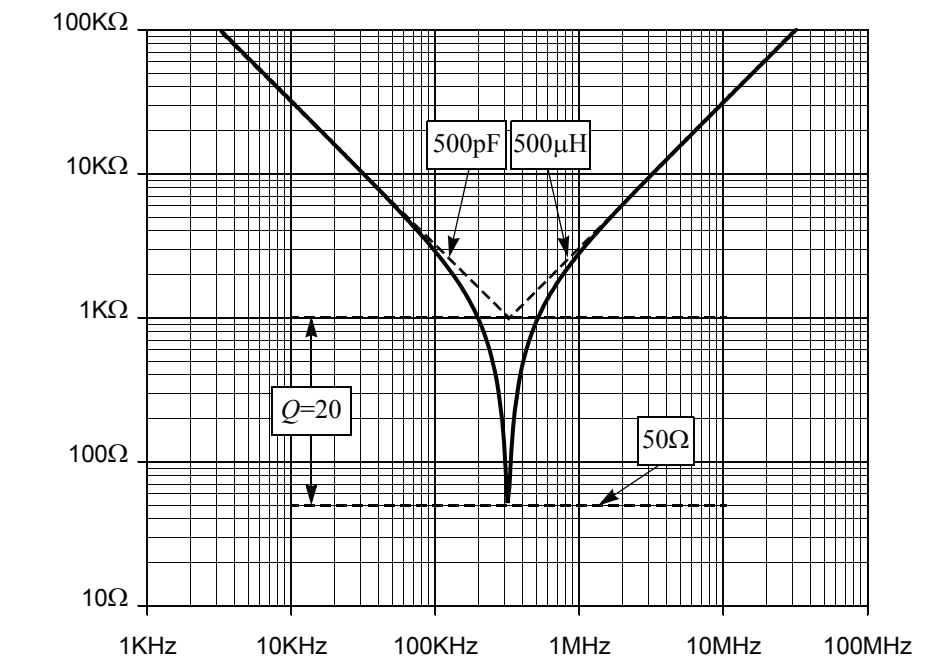

$$Q = \frac{|Z_L(f_0)|}{R} = \frac{1}{R} \sqrt{\frac{L}{C}} \tag{49}$$

In this case $Q = 20$. When drawing impedance curve by inspection, remember that if you get an abrupt change of slope from -1 to 1 or from 1 to -1 you will get a resonance (a null or peak) from the cancellation that occurs. This can be generalized to saying that any abrupt slope change by 2 in either direction (say from 0 to ± 2 or from ± 2 to 0) creates a resonance.

Finally, consider a shunt combination of RLC. Figure 8 shows the shunt combination of a $500\mu\text{H}$ inductor, a 500pF capacitor, and $20\text{k}\Omega$ resistor. As before, a resonance occurs at

$$f_0 = \frac{1}{2\pi\sqrt{LC}} \tag{50}$$

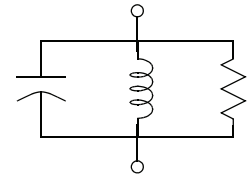

but now the Q is the ratio between the resistance of the resistor and the reactance of the capacitor or inductor at resonance:

$$Q = \frac{R}{\sqrt{\frac{L}{C}}} = R \sqrt{\frac{C}{L}} \tag{51}$$

in this case $Q = 20$ again.

FIGURE 8 The shunt combination of a $500\mu\text{H}$ inductor, a 500pF capacitor, and $20\text{k}\Omega$ resistor.

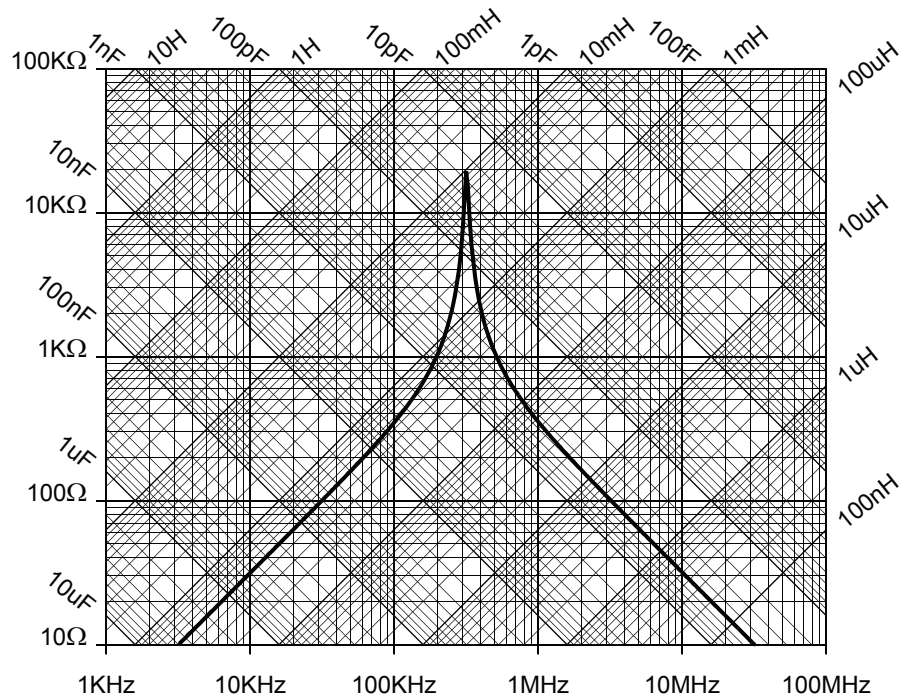

The techniques presented so far allow you to quickly picture the immittance of simple collections of linear resistors, capacitors, and inductors with the only assumption being

that the components can be organized as series and parallel combinations. It is important to recognize that these series and parallel combinations can be built up hierarchically. For example, Figure 9 shows a 20Ω resistor in series with the parallel RLC of Figure 8.

FIGURE 9 The parallel RLC of Figure 8 with a series 20Ω resistor.

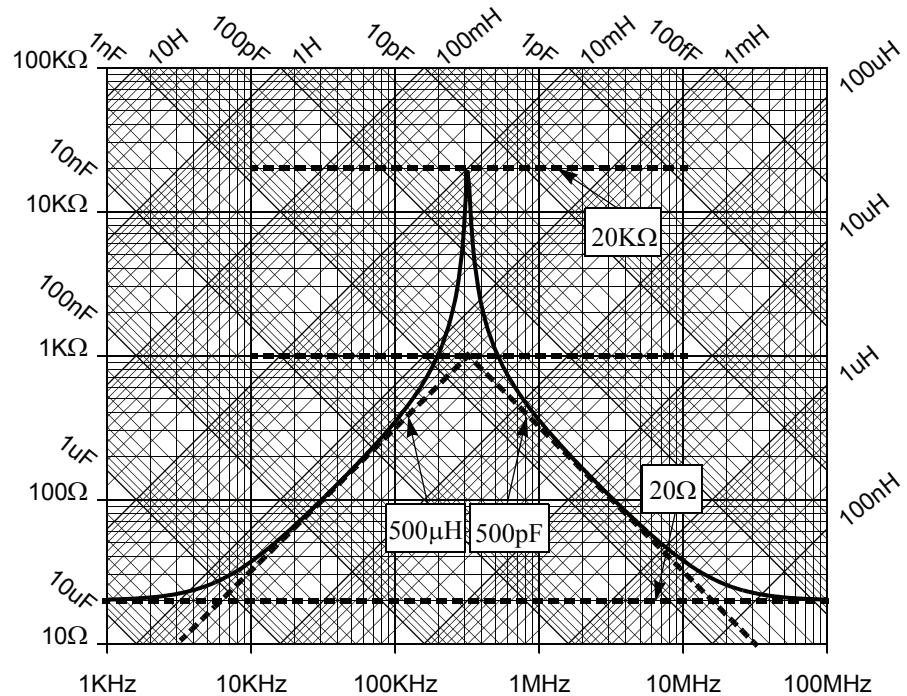

The basic approach is to draw straight lines on a log-log immittance chart to represent each of the individual components. Resistors will be represented with lines that have a slope of 0. Capacitors and inductors are represented with lines that have a slope of either +1 or -1 (depending on the type of the component and the type of the immittance). The process is aided by capacitance and inductance overlays. Then you draw a curve that represents the desired immittance by recognizing how the immittances combine based on whether they are series or shunt combinations. This is illustrated in Figure 8.

1. The series combination of two impedances will follow the largest impedance.
2. The series combination of two admittances will follow the smallest admittance.
3. The shunt combination of two impedances will follow the smallest impedance.
4. The shunt combination of two admittances will follow the largest admittance.
5. A change of slope of either +1 or -1 will be smooth and the transition takes a decade.
6. A change of slope of either +2 or -2 will create a resonance and so will be peaked; the width of the peak will also be a decade.

9 Voltage and Current Dividers

So far the focus has been on determining the immittance of series and parallel combinations of linear resistors, capacitors and inductors. Now the focus turns to determining the transfer function of simple filters. Determining the transfer function of a circuit requires that an input and output is identified for the circuit, then the transfer function is simply the ratio of the phasor representation of the output divided by the phasor representation of the input. Immittances can be seen as transfer functions. For example, a current being applied to a component acts as an input, if you then consider the voltage across the component as the output, then the transfer function is V/I , which is the impedance Z of that component. However, the input to be applied and the output to be observed need not be at the same points in the circuit. A common example would be to have a circuit where both the input and output is a voltage. In this case the transfer function is the voltage gain, which is simply $A_v = V_{\text{out}}/V_{\text{in}}$. It is also possible for the input signal to be a different type than the output signal. For example, it might be that the input is a current and the output is a voltage. In this case the gain has units of resistance. If the input and output are found at different points in the circuit then the gain is referred to as transresistance and often denoted $R = V_{\text{out}}/I_{\text{in}}$. If the output were a current and the input were a voltage then the gain is called transconductance and denoted $G = I_{\text{out}}/V_{\text{in}}$. One assumption that will be made to make everything much simpler is that the circuit we are analyzing does not load the input source and in turn is not loaded by anything observing the output. In other words the signal provided by the input source is not materially affected by connecting our circuit to it, and our circuit is not materially affected by what ever additional circuit is connected to its output.

A voltage divider and a current divider is shown in Figure 10. The transfer function of the voltage divider (the ratio of its output to its input) can be found by applying a voltage to the input, computing the current through the series combination of Z_1 and Z_2 , and then using that current determine the voltage on Z_2 , which is the output voltage. This assumes that no current flows through the output.

FIGURE 10 *A voltage divider and a current divider.*

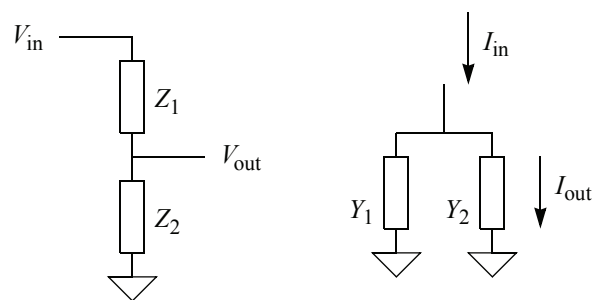

$$I = \frac{V_{\text{in}}}{Z_1 + Z_2}, \quad (52)$$

$$V_{\text{out}} = IZ_2 = \frac{Z_2}{Z_1 + Z_2} V_{\text{in}}. \quad (53)$$

Now, to visualize the transfer function of this voltage divider you would plot Z_2 and $Z_1 + Z_2$ on a log-log plot (hopefully you can now do this by inspection) and then plot the difference (division is implemented as subtraction on a log-log plot).

In the case of the current divider, the admittance seen by I_{in} is $Y_1 + Y_2$ and so the voltage at the top of Y_1 and Y_2 is

$$V = \frac{I_{in}}{Y_1 + Y_2}, \quad (54)$$

$$I_{out} = Y_2 V = \frac{Y_2}{Y_1 + Y_2} I_{in}. \quad (55)$$

As an example of working with voltage dividers, consider the classic oscilloscope probe compensation problem. Assume a 100MHz oscilloscope whose input can be modeled as a $1\text{M}\Omega$ resistor in parallel with a 2pF capacitor. This is too heavy of a load

for you to apply to your sensitive circuit without affecting its behavior, but you are willing to trade off signal level to reduce loading so you decide to add a $9\text{M}\Omega$ resistor in series with input of the scope. At DC you can ignore the capacitor because at DC it acts like it does not exist, and so the transfer function would be $1\text{M}\Omega / (1\text{M}\Omega + 9\text{M}\Omega) = 0.1$. In other words, at DC the probe acts like a $\div 10$. However, plotting Z_1 and Z_2 as done in Figure 11 shows if you subtracted them, you would see a roll off at roughly 100kHz, which would be annoying since you paid so much to get a 100MHz oscilloscope. Hopefully examining this graph suggests the solution. What is needed is for the top curve to also roll off at 100kHz, in this way the two curves will maintain a constant distance and so the transfer function of the probe will be flat and you will get the 100MHz bandwidth you paid for.

To maintain a constant distance between the two curves a shunt capacitance must be added the top leg of the voltage divider to implement the roll off in its impedance. At low frequencies the ratio between the resistance of the top leg and the bottom leg is 9:1, and so to maintain the same distance at high frequencies the new capacitor must be 9 times smaller than the input capacitance of the oscilloscope. This also results in the corner frequency for Z_1 to be the same as that for Z_2 . The result is shown in Figure 12.

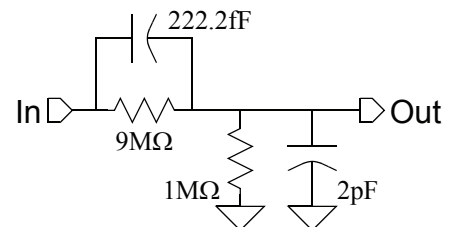
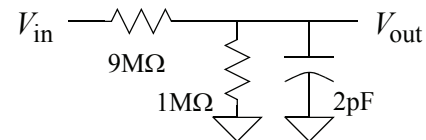

10 Simple Filters

From (12) and (23) the impedance of a resistor is

$$Z_R = R. \quad (56)$$

FIGURE 11 *Impedances found in an oscilloscope probe before compensation.*

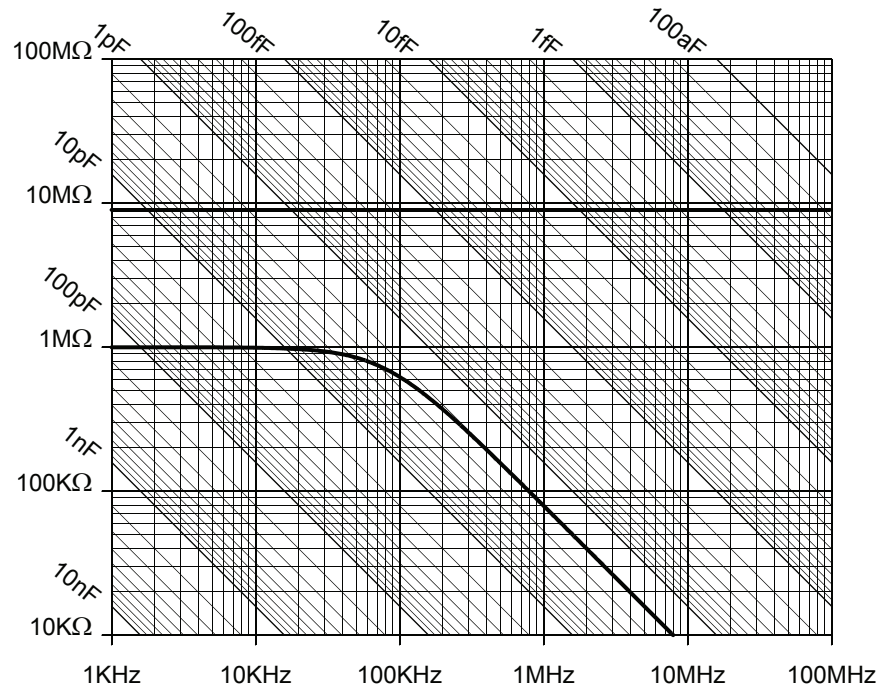
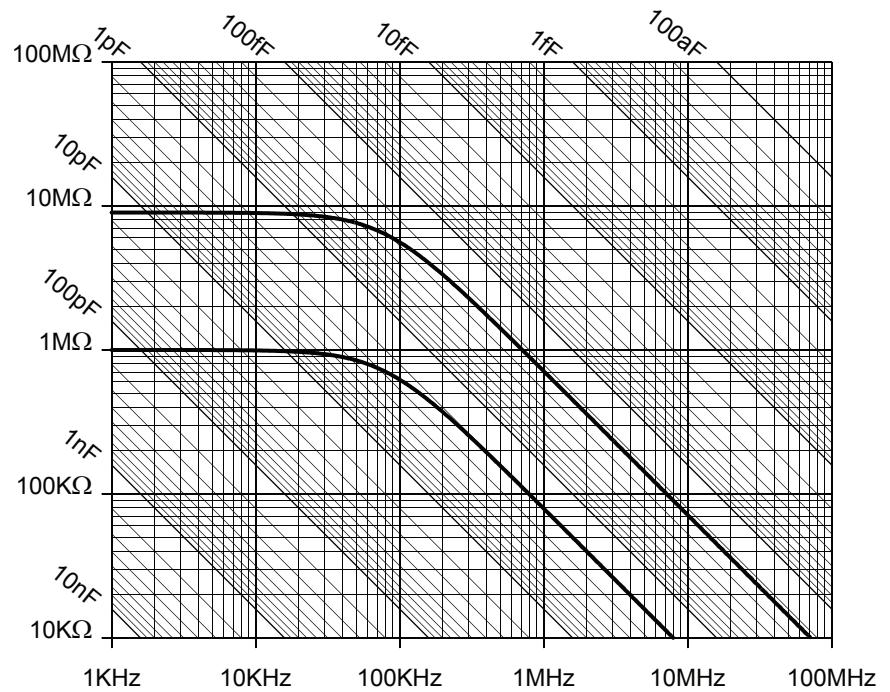

FIGURE 12 *Impedances found in an oscilloscope probe after compensation.*



The impedance of a resistor is constant with frequency. From (17) and (23) the impedance of a capacitor is

$$Z_C = \frac{1}{j\omega C}. \quad (57)$$

The impedance of a capacitor is high at low frequencies and low at high frequencies. As such, you can combine resistors and capacitors as a voltage divider to make simple filters. For example, you can make a simple low-pass filter by putting the resistor as the top leg of the divider and the capacitor as the bottom leg, as shown to the right. You can

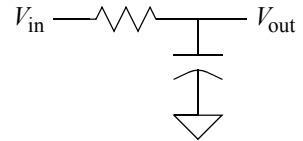

draw the graph as described above by drawing both the impedance of the capacitor (Z_2) and the sum of the impedances of the resistor and the capacitor ($Z_1 + Z_2$), and plotting the difference. However, in this case there is an easier approach. At low frequencies, the impedance of the capacitor will be much larger than that of the resistor, so from (53) it is clear that at low frequencies the gain from input to output will be unity. At high frequencies the impedance of the resistor will be much greater than the impedance of the capacitor, and so the gain through the filter will be much less than unity. The corner occurs at the frequency where the magnitude of the impedances of the resistor and capacitor are the same, and we have already calculated that in (39) to be

$$f_c = \frac{1}{2\pi RC}. \quad (58)$$

Thus, the gain will be unity at low frequencies and will drop off at frequencies above the corner frequency at a rate that approaches -1 on a log-log scale. As with impedance, you can draw a straight line along the gain=1 line from low frequencies to the corner frequency, and then draw a new line with slope -1 starting from there as an approximation to the transfer function of the filter. The true transfer function will be a smoothed version of that, which asymptotically approaches it at high and low frequencies, as shown in Figure 13 for the case where the resistor is $1\text{k}\Omega$ and the capacitor is 1nF .

FIGURE 13 *The transfer function of a lowpass RC filter with $R=1\text{k}\Omega$ and $C=1\text{nF}$.*

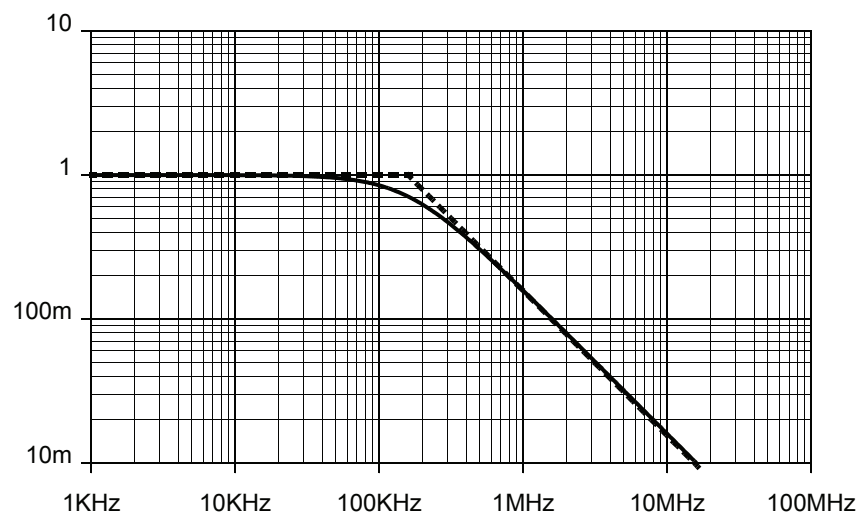

Using these ideas you can build simple low-pass and high-pass filters using resistor and either capacitors or inductors. The various structures you would use are shown in Figure 14. It is worth thinking about the role of the various components in these filters. It is the nature of capacitors to pass high frequency signals and block low frequency signals. In the high-pass RC filter the capacitor is placed in series with the signal path, and so it does exactly that. However in the low-pass RC filter the capacitor connects from the signal path to ground, so it acts to shunt the high frequency signals to ground so they are not available to the output. It is the nature of inductors to pass low frequency signals and block high frequency signals. Thus you build a low-pass RL filter by putting the inductor in series with the signal path and you build a high-pass RF filter by connecting the inductor from the signal path to ground.

FIGURE 14 Simple first-order low-pass and high-pass filter structures.

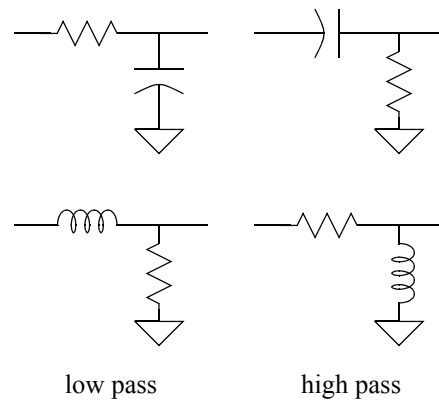

11 Simple Active Filters

A basic assumption made earlier when introducing the idea of a transfer function for a filter is that the filter should not load the input source nor should it in turn be loaded by any observer connected to the output. This makes it difficult to chain together several filters because they tend to interact with each other in complicated ways. One way to address this is to build active filters using opamps. The opamps tend to isolate the filters. A simple example of this the active filter shown in Figure 15. The ideas presented in this paper along with those presented in the *Introduction to Feedback* [2] will be used to analyze this filter.

This circuit take the form of an inverting amplifier, and its transfer function is

$$A_v = -\frac{Z_f}{Z_i}. \quad (59)$$

Using the techniques described in Section 8 the composite feedback and input impedances can be quickly determined and are shown in Figure 16. Now the magnitude of the gain is determined by taking the ratio of Z_f and Z_i , which is the equivalent of subtraction on a log-log grid. The magnitude of the gain is shown in Figure 17. By examining these graphs it is easy to determine that the feedback network has a corner near 1kHz that sets

FIGURE 15 A simple filter that employs an opamp.

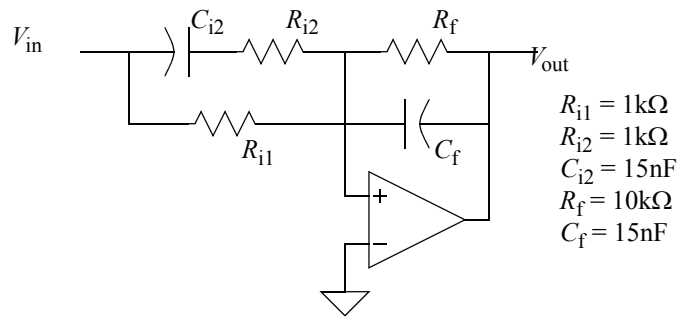
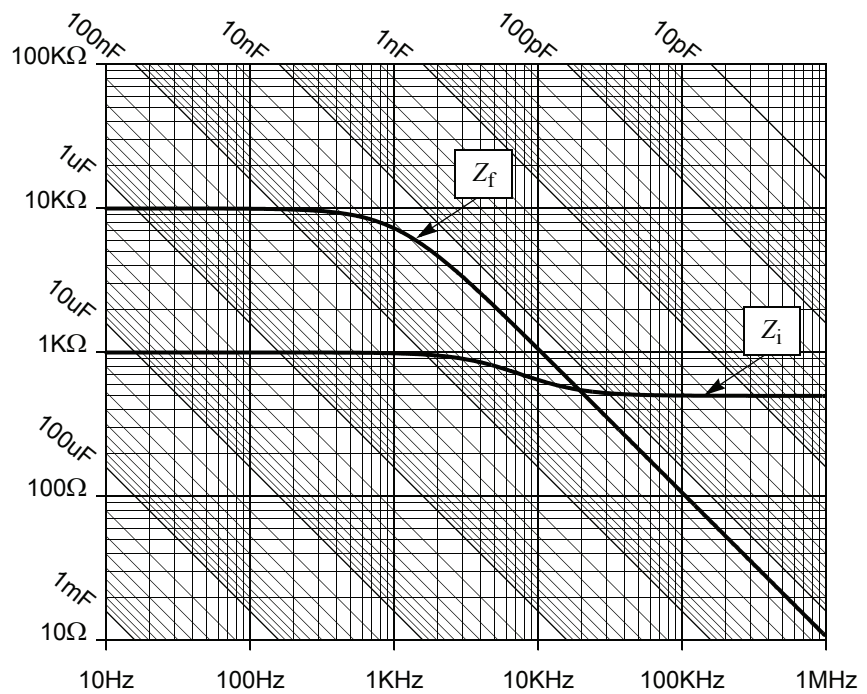

FIGURE 16 The input and feedback impedances of the active filter of Figure 16.



the primary bandwidth of the filter, and the ratio of $-R_f/R_{i1}$ sets the low frequency gain. In addition, R_{i2} and C_{i2} provides a path around R_{i1} at high frequencies that acts to boost the gain by a factor of 2 at frequencies above a few kilohertz.

12 Conclusion

The ideas presented in this paper allow you to quickly gain a reasonably understanding of a wide variety of simply RLC circuits. When combined with a basic understanding of opamps[2] there is a surprising number of useful circuits you can quickly understand and design.

FIGURE 17 *The magnitude of the gain of the active filter of Figure 16.*

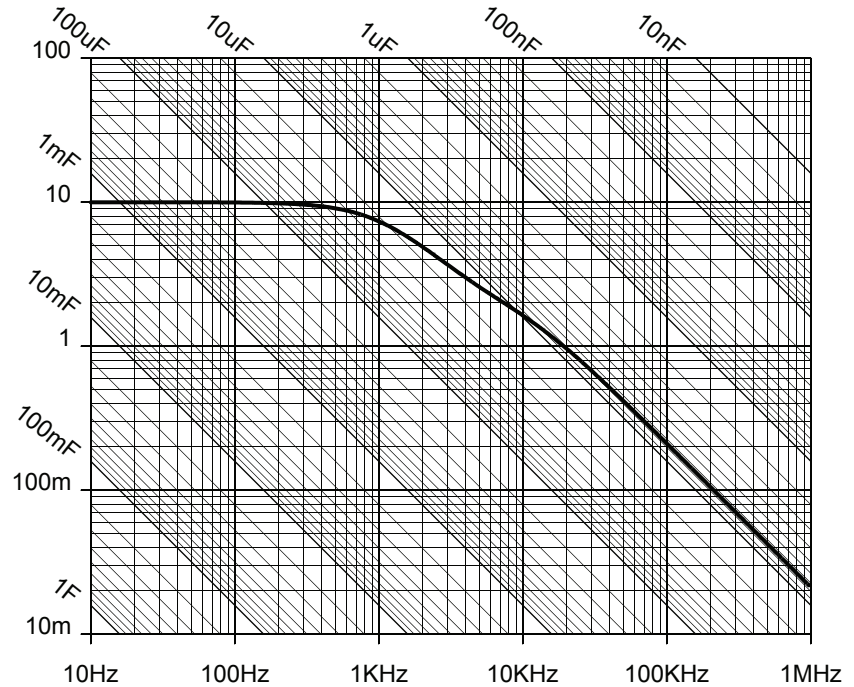

12.1 If You Have Questions

If you have questions about what you have just read, feel free to post them on the *Forum* section of *The Designer's Guide Community* website. Do so by going to www.designers-guide.org/Forum.

Appendix A Immittance Charts

So that you can quickly analyze your own circuits, two immittance charts have been attached to the end of this document. One is configured as an impedance chart and labeled with typical values. The other is unlabeled so that you can use it for arbitrary circuits.

References

- [1] Charles Desoer and Ernest Kuh. *Basic Circuit Theory*. McGraw Hill. 1969.
- [2] Ken Kundert. Introduction to Feedback. www.designers-guide.org/Theory.
- [3] Ken Kundert. Introduction to the Fourier Series. www.designers-guide.org/Theory.

Index**A**

active filter 19
admittance 6

C

conductance 6
current divider 15

F

filter 14
frequency response 2

I

immittance 7
impedance 5

L

linearity 2

P

phasor 3
phasor analysis 2

Q

quality factor 12

R

reactance 5
resistance 5
resonance 12

S

steady-state 2
superposition 3
susceptance 6

T

transfer function 14, 15

V

voltage divider 15

