



Catalog of CHP Technologies

**U.S. Environmental Protection Agency
Combined Heat and Power Partnership**



September 2017

Disclaimer

The information contained in this document is for information purposes only and is gathered from published industry sources. Information about costs, maintenance, operations, or any other performance criteria is by no means representative of EPA, ORNL, or ICF policies, definitions, or determinations for regulatory or compliance purposes.

The September 2017 revision incorporated a new section on packaged CHP systems (Section 7).

This Guide was prepared by Ken Darrow, Rick Tidball, James Wang and Anne Hampson at ICF International, with funding from the U.S. Environmental Protection Agency and the U.S. Department of Energy.

Table of Contents

Section 1. Introduction.....	1-1
1.1 Overview of CHP Technologies.....	1-2
1.2 CHP Efficiency Compared to Separate Heat and Power	1-8
1.3 Emissions	1-10
1.4 Comparison of Water Usage for CHP compared to SHP	1-12
1.5 Outlook.....	1-13
Section 2. Technology Characterization – Reciprocating Internal Combustion Engines....	2-1
2.1 Introduction.....	2-1
2.2 Applications.....	2-2
2.2.1 Combined Heat and Power.....	2-2
2.2.2 Emergency/Standby Generators.....	2-3
2.2.3 Peak Shaving	2-3
2.3 Technology Description.....	2-3
2.3.1 Basic Processes.....	2-3
2.3.2 Components.....	2-5
2.3.2.1 Engine System	2-5
2.3.2.2 Diesel Engines	2-6
2.3.2.3 Dual Fuel Engines	2-7
2.3.2.4 Heat Recovery	2-8
2.4 Performance Characteristics	2-9
2.4.1 Part Load Performance.....	2-11
2.4.2 Effects of Ambient Conditions on Performance.....	2-12
2.4.3 Engine Speed Classifications.....	2-12
2.4.4 Performance and Efficiency Enhancements	2-13
2.4.4.1 Brake Mean Effective Pressure (BMEP) and Engine Speed.....	2-13
2.4.4.2 Turbocharging.....	2-14
2.4.5 Capital Costs.....	2-14
2.4.6 Maintenance.....	2-16
2.4.7 Fuels	2-17
2.4.7.1 Liquefied Petroleum Gas.....	2-18
2.4.7.2 Field Gas	2-18
2.4.7.3 Biogas.....	2-19
2.4.7.4 Industrial Waste Gases	2-19
2.4.8 System Availability	2-20

Table of Contents (continued)

2.5	Emissions and Emissions Control Options.....	2-20
2.5.1	Emissions Characteristics	2-21
2.5.1.1	Nitrogen Oxides (NO _x).....	2-21
2.5.1.2	Carbon Monoxide (CO)	2-21
2.5.1.3	Unburned Hydrocarbons.....	2-22
2.5.1.4	Carbon Dioxide (CO ₂).....	2-22
2.5.2	Emissions Control Options	2-22
2.5.2.1	Combustion Process Emissions Control	2-22
2.5.2.2	Post-Combustion Emissions Control.....	2-24
2.5.2.3	Oxidation Catalysts	2-24
2.5.2.4	Diesel Particulate Filter	2-24
2.5.2.5	Three-Way Catalyst (Non Specific Catalytic Reduction).....	2-24
2.5.2.6	Selective Catalytic Reduction (SCR).....	2-25
2.5.3	Gas Engine Emissions Treatment Comparison	2-25
2.6	Future Developments	2-26
Section 3.	Technology Characterization – Combustion Turbines	3-1
3.1	Introduction.....	3-1
3.2	Applications.....	3-1
3.3	Technology Description.....	3-2
3.3.1	Basic Process.....	3-2
3.3.2	Components.....	3-4
3.3.2.1	Types of Gas Turbines	3-5
3.4	Performance Characteristics	3-5
3.4.1	Fuel Supply Pressure	3-7
3.4.2	Heat Recovery	3-8
3.4.3	Part-Load Performance	3-9
3.4.4	Effects of Ambient Conditions on Performance.....	3-10
3.4.4.1	Ambient Air Temperature.....	3-10
3.4.4.2	Site Altitude	3-12
3.4.5	Capital Costs.....	3-12
3.4.6	Maintenance	3-14
3.4.7	Fuels	3-15
3.4.8	Gas Turbine System Availability.....	3-16
3.5	Emissions and Emissions Control Options.....	3-16
3.5.1	Emissions.....	3-16
3.5.2	Emissions Control Options	3-17

Table of Contents (continued)

3.5.2.1	Diluent Injection.....	3-18
3.5.2.2	Lean Premixed Combustion	3-18
3.5.2.3	Selective Catalytic Reduction (SCR).....	3-18
3.5.2.4	CO Oxidation Catalysts.....	3-19
3.5.2.5	Catalytic Combustion.....	3-19
3.5.2.6	Catalytic Absorption Systems.....	3-19
3.6	Future Developments	3-20
Section 4.	Technology Characterization – Steam Turbines.....	4-1
4.1	Introduction.....	4-1
4.2	Applications.....	4-2
4.3	Technology Description.....	4-3
4.3.1	Basic Process.....	4-3
4.3.2	Components.....	4-3
4.3.2.1	Boiler	4-4
4.3.2.2	Steam Turbine.....	4-4
4.3.2.3	Condensing Turbine.....	4-6
4.3.2.4	Non-Condensing (Back-pressure) Turbine.....	4-7
4.3.2.5	Extraction Turbine.....	4-8
4.4	Performance Characteristics	4-9
4.4.1	Performance Losses	4-11
4.4.2	Performance Enhancements.....	4-12
4.4.2.1	Steam Reheat	4-12
4.4.2.2	Combustion Air Preheating.....	4-12
4.4.3	Capital Costs.....	4-12
4.4.4	Maintenance.....	4-14
4.4.5	Fuels	4-15
4.4.6	System Availability	4-15
4.5	Emissions and Emissions Control Options.....	4-15
4.5.1	Boiler Emissions Control Options - NO _x	4-16
4.5.1.1	Combustion Process emissions Control.....	4-16
4.5.1.2	Flue Gas Recirculation (FGR).....	4-17
4.5.1.3	Low Excess Air Firing (LAE)	4-17
4.5.1.4	Low Nitrogen Fuel Oil.....	4-17
4.5.1.5	Burner Modifications.....	4-17
4.5.1.6	Water/Steam Injection	4-18
4.5.2	Post-Combustion Emissions Control.....	4-18

Table of Contents (continued)

4.5.2.1	Selective Non-Catalytic Reduction (SNCR).....	4-18
4.5.2.2	Selective Catalytic Reduction (SCR).....	4-18
4.5.2.3	Boiler Emissions Control Options – SO _x	4-18
4.6	Future Developments	4-19
Section 5.	Technology Characterization – Microturbines	5-1
5.1	Introduction.....	5-1
5.2	Applications.....	5-1
5.3	Technology Description.....	5-2
5.3.1	Basic Process.....	5-2
5.3.2	Components.....	5-3
5.3.2.1	Turbine & Compressor	5-3
5.3.2.2	Generator	5-4
5.3.2.3	Recuperator & Combustor	5-5
5.3.2.4	CHP Heat Exchanger.....	5-5
5.4	Performance Characteristics	5-5
5.4.1	Part-Load Performance	5-7
5.4.2	Effects of Ambient Conditions on Performance.....	5-8
5.4.3	Capital Cost	5-12
5.4.4	Maintenance.....	5-14
5.4.5	Fuels	5-16
5.4.6	System Availability	5-16
5.5	Emissions	5-16
5.6	Future Developments	5-17
Section 6.	Technology Characterization – Fuel Cells.....	6-1
6.1	Introduction.....	6-1
6.2	Applications.....	6-3
6.2.1	Combined Heat and Power.....	6-4
6.2.2	Premium Power.....	6-4
6.2.3	Remote Power	6-5
6.2.4	Grid Support.....	6-5
6.2.5	Peak Shaving	6-5
6.2.6	Resiliency.....	6-6
6.3	Technology Description.....	6-6
6.3.1	Basic Processes and Components.....	6-6
6.3.1.1	Fuel Cell Stacks.....	6-9

Table of Contents (continued)

6.3.1.2	Fuel Processors.....	6-9
6.3.1.3	Power Conditioning Subsystem	6-10
6.3.1.4	Types of Fuel Cells.....	6-10
6.3.1.5	PEMFC (Proton Exchange Membrane Fuel Cell or Polymer Electrolyte Membrane).....	6-11
6.3.1.6	PAFC (Phosphoric Acid Fuel Cell)	6-11
6.3.1.7	MCFC (Molten Carbonate Fuel Cell)	6-12
6.3.1.8	SOFC (Solid Oxide Fuel Cell)	6-12
6.4	Performance Characteristics	6-13
6.4.1	Electrical Efficiency	6-14
6.4.2	Part Load Performance.....	6-14
6.4.3	Effects of Ambient Conditions on Performance.....	6-15
6.4.4	Heat Recovery	6-15
6.4.5	Performance and Efficiency Enhancements	6-16
6.4.6	Capital Cost	6-16
6.4.7	Maintenance	6-17
6.4.8	Fuels	6-17
6.4.9	System Availability	6-18
6.5	Emissions and Emissions Control Options.....	6-18
6.5.1	Primary Emissions Species.....	6-18
6.5.1.1	Nitrogen Oxides (NO _x).....	6-18
6.5.1.2	Carbon Monoxide (CO)	6-19
6.5.1.3	Unburned Hydrocarbons.....	6-19
6.5.1.4	Carbon Dioxide (CO ₂).....	6-19
6.5.2	Fuel Cell Emission Characteristics.....	6-19
6.6	Future Developments	6-20
Section 7.	Packaged CHP Systems	7-1
7.1	Introduction.....	7-1
7.2	The Evolution of Packaged CHP Systems.....	7-1
7.3	Significant Attributes.....	7-4
7.3.1	Standardization	7-4
7.3.2	Black Start/Islanding Capability.....	7-4
7.3.3	Acoustic Enclosure.....	7-5
7.3.4	Modularity.....	7-5
7.3.5	Third-Party Own/Operate Business Arrangements.....	7-6
7.3.6	Replicability.....	7-6

Table of Contents (continued)

7.4 Applications.....	7-6
7.4.1 Installed Packaged Systems	7-7
7.4.2 Technical Potential	7-9
7.5 Technology Description.....	7-10
7.5.1 Heat Recovery	7-11
7.6 Cost and Performance Characteristics.....	7-12
7.6.1 Part-Load Operation	7-13
7.6.2 Installed Costs	7-13
7.6.3 Maintenance Costs	7-14
7.6.4 Fuels	7-15
7.7 Emissions, Emissions Control Options, and Prime Mover Certification.....	7-15

Appendix A: Expressing CHP Efficiency

List of Figures

Figure 1-1. CHP versus Separate Heat and Power (SHP) Production	1-9
Figure 1-2. Equivalent Separate Heat and Power Efficiency.....	1-10
Figure 2-1. 4-Stroke Reciprocating Engine Cycle.....	2-4
Figure 2-2. Closed-Loop Heat Recovery System.....	2-9
Figure 2-3. Part Load Generator Terminal Efficiency, System 5.....	2-12
Figure 3-1. Gas Turbine Configuration with Heat Recovery	3-3
Figure 3-2. Components of Simple Cycle Gas Turbine.....	3-4
Figure 3-3. Heat Recovery from a Gas Turbine System	3-8
Figure 3-4. Effect of Part Load Operation on Electrical Efficiency.....	3-10
Figure 3-5. Effect of Ambient Temperature on Capacity and Efficiency.....	3-11
Figure 3-6. The Effect of Altitude on Gas Turbine Capacity.....	3-12
Figure 4-1. Boiler/Steam Turbine System.....	4-3
Figure 4-2. Comparison of Impulse and Reaction Turbine Design.....	4-5
Figure 4-3. Condensing Steam Turbine.....	4-7
Figure 4-4. Non-Condensing (Back-pressure) Steam Turbine.....	4-7
Figure 4-5. Extraction Steam Turbine.....	4-8
Figure 5-1. Microturbine-based CHP System Schematic.....	5-3
Figure 5-2. Compact Microturbine Design.....	5-5
Figure 5-3. Part Load Efficiency at ISO Conditions, Capstone C65.....	5-8
Figure 5-4. Temperature Effect on Power, Capstone C200-LP	5-9
Figure 5-5. Temperature Effect on Efficiency, Capstone C200-LP	5-10
Figure 5-6. Temperature Effect on Power and Efficiency, FlexEnergy MT250	5-10
Figure 5-7. Ambient Elevation vs. Temperature Derating, Capstone C65	5-12
Figure 5-8. Capstone C370 Two-shaft High Efficiency Turbine Design.....	5-18
Figure 6-1. Commercial Fuel Cell for CHP Application.....	6-4
Figure 6-2. Fuel Cell Electrochemical Process	6-7
Figure 6-3. Effect of Operating Temperature on Fuel Cell Efficiency	6-9
Figure 6-4. Comparison of Part Load Efficiency Derate	6-15
Figure 6-5. Recent Worldwide Fuel Cell Installations by Fuel Cell Type, in Megawatts.....	6-20
Figure 7-1. Annual U.S. Capacity Additions: Packaged CHP Systems.....	7-2
Figure 7-2. Aegis ThermoPower (TP-75), 75 kW.....	7-3
Figure 7-3. Tecogen Tecopower CM-75, 75 kW.....	7-3
Figure 7-4. MTU 12V400 GS, 358 kW.....	7-3
Figure 7-5. Capstone C65 ICHP, 65 kW	7-3
Figure 7-6. Amerigen 8150 (Using the MAN E2876 E312 Engine), 150 kW	7-3
Figure 7-7. Energy Choice EC 190 Natural Gas system, 190 kW	7-3

List of Figures (Continued)

Figure 7-8. 2G Avus 800, 800 kW	7-3
Figure 7-9. Siemens SGE-36SL, 676 kW	7-3
Figure 7-10. Packaged System Installations by Market Segment.....	7-7
Figure 7-11. Packaged System Installations and Capacity by Size Range	7-9
Figure 7-12. Technical Potential for <500 kW Packaged CHP Applications in the Commercial and Institutional Sectors, by Market Segment.....	7-10
Figure 7-13. Packaged CHP System Diagram	7-11

List of Tables

Table 1-1. U.S. Installed CHP Sites and Capacity by Prime Mover	1-3
Table 1-2. Summary of CHP Technology Advantages and Disadvantages.....	1-4
Table 1-3. Comparison of CHP Technology Sizing, Cost, and Performance Parameters	1-6
Table 1-4. Water Consumption by SHP Technology, Cooling Technology.....	1-12
Table 2-1. Reciprocating Engine Characteristics.....	2-1
Table 2-2. Gas Spark Ignition Engine CHP - Typical Performance Parameters	2-10
Table 2-3. Reciprocating Engine Types by Speed (Available MW Ratings).....	2-13
Table 2-4. Estimated Capital Cost for Typical Gas Engine Generators in Grid Interconnected CHP Applications.....	2-15
Table 2-5. Representative Overhaul Intervals for Natural Gas Engines in Baseload Service	2-16
Table 2-6. Typical Natural Gas Engine Maintenance Costs (\$2013/kWh)	2-17
Table 2-7. Major Constituents and LHV of Gaseous Fuels	2-18
Table 2-8. Availabilities and Outage Rates for Natural Gas Engines	2-20
Table 2-9. Uncontrolled NO _x Emissions versus Efficiency Tradeoffs	2-23
Table 2-10. Post-Combustion Exhaust Gas Cleanup Options.....	2-24
Table 2-11. Gas Engine Emissions Characteristics with Available Exhaust Control Options.....	2-26
Table 3-1. Gas Turbine Design Characteristics.....	3-4
Table 3-2. Typical Performance for Gas Turbines in CHP Operation	3-6
Table 3-3. Power Requirements for Natural Gas Fuel Compression	3-8
Table 3-4. Cost Estimation Parameters.....	3-13
Table 3-5. Estimated Capital Cost for Representative Gas Turbine CHP Systems	3-14
Table 3-6. Gas Turbine Non-Fuel O&M Costs	3-15
Table 3-7. Gas Turbine Availability and Outage Rates	3-16
Table 3-8. Gas Turbine Emissions Characteristics	3-17
Table 4-1. Summary of Steam Turbine Attributes.....	4-1
Table 4-2. Backpressure Steam Turbine Cost and Performance Characteristics*	4-10
Table 4-3. Steam Turbine Availability	4-15
Table 4-4. Typical Boiler Emissions Ranges.....	4-16
Table 5-1. Summary of Microturbine Attributes.....	5-1
Table 5-2. Microturbine Cost and Performance Characteristics.....	5-6
Table 5-3. Equipment and Installation Costs	5-13
Table 5-4. Example Service Schedule, Capstone C65	5-14
Table 5-5. Maintenance Costs Based on Factory Service Contracts	5-15
Table 5-6. Microturbine Emissions Characteristics.....	5-17
Table 6-1. Comparison of Fuel Cell Applications, Advantages, and Disadvantages	6-2
Table 6-2. Characteristics of Major Fuel Cell Types.....	6-11
Table 6-3. Fuel Cell CHP - Typical Performance Parameters	6-13

List of Tables (Continued)

Table 6-4. Estimated Capital and O&M Costs for Typical Fuel Cell Systems in Grid Interconnected CHP Applications (2014 \$/kW)	6-17
Table 6-5. Estimated Fuel Cell Emission Characteristics without Additional Controls	6-19
Table 7-1. Packaged Systems Total Installed Capacity and Median Size by Market Segment.....	7-8
Table 7-2. Packaged CHP Systems – Performance Characteristics.....	7-12
Table 7-3. Packaged CHP Systems – Equipment Costs.....	7-14
Table 7-4. Packaged CHP Systems – Maintenance Costs.....	7-14

Section 1. Introduction

Combined heat and power (CHP) is an efficient and clean approach to generating electric power and useful thermal energy from a single fuel source. CHP places power production at or near the end-user's site so that the heat released from power production can be used to meet the user's thermal requirements while the power generated meets all or a portion of the site electricity needs. Applications with steady demand for electricity and thermal energy are potentially good economic targets for CHP deployment. Industrial applications particularly in industries with continuous processing and high steam requirements are very economic and represent a large share of existing CHP capacity today. Commercial applications such as hospitals, nursing homes, laundries, and hotels with large hot water needs are well suited for CHP. Institutional applications such as colleges and schools, prisons, and residential and recreational facilities are also excellent prospects for CHP.

The direct benefits of combined heat and power for facility operators are:

- **Reduced energy related costs** – providing direct cost savings.
- Increased reliability and decreased risk of power outages due to the addition of a separate power supply.
- Increased economic competitiveness due to lower cost of operations.

In addition to these direct benefits, the electric industry, electricity customers, and society, in general, derive benefits from CHP deployment, including:

- **Increased energy efficiency** – providing useful energy services to facilities with less primary energy input.
- **Economic development value** – allowing businesses to be more economically competitive on a global market thereby maintaining local employment and economic health.
- **Reduction in emissions that contribute to global warming** – increased efficiency of energy use allows facilities to achieve the same levels of output or business activity with lower levels of fossil fuel combustion and reduced emissions of carbon dioxide.
- **Reduced emissions of criteria air pollutants** – CHP systems can reduce air emissions of carbon monoxide (CO), nitrogen oxides (NO_x), and Sulfur dioxide (SO₂) especially when state-of-the-art CHP equipment replaces outdated and inefficient boilers at the site.
- Increased reliability and grid support for the utility system and customers as a whole.
- **Resource adequacy** – reduced need for regional power plant and transmission and distribution infrastructure construction.

CHP systems consist of a number of individual components – prime mover (heat engine), generator, heat recovery, and electrical interconnection – configured into an integrated whole. The type of equipment that drives the overall system (i.e., the prime mover) typically identifies the CHP system. The purpose of this guide is to provide CHP stakeholders with a description of the cost and performance of complete systems powered by prime-mover technologies consisting of:

1. Reciprocating internal combustion engines
2. Combustion turbines
3. Steam turbines
4. Microturbines
5. Fuel cells

In 2008, the EPA CHP Partnership Program published its first catalog of CHP technologies as an online educational resource for regulatory, policy, permitting, and other interested CHP stakeholders. This *CHP Technology Guide* is an update to the 2008 report¹. The Guide includes separate, detailed chapters on each of the five prime movers listed above. These technology chapters include the following information:

- Description of common applications
- Basic technology description
- Cost and performance characteristics
- Emissions and emissions control options
- Future developments

Packaged CHP Systems

In September 2017, the EPA CHP Partnership added a new section (Section 7) to the Catalog that provides information on packaged CHP systems. Specifically, the section discusses:

- The evolution of packaged CHP systems
- Significant attributes
- Applications
- Technology description
- Cost and Performance characteristics
- Emissions and emission control options

This introduction and overview section provides a discussion of the benefits of CHP technologies, a summary comparison of the five main prime-mover technology systems, and a discussion of key CHP benefits. There is also an appendix that provides the formulas for the various performance measurements used in the Guide.

1.1 Overview of CHP Technologies

The five technologies described in the Guide make up 97 percent of the CHP projects in place today and 99 percent of the total installed CHP electric capacity. **Table 1-1** shows the breakdown by each prime mover technology.

¹ Catalog of CHP Technologies, U.S. Environmental Protection Agency Combined Heat and Power Partnership Program, December 2008.

Table 1-1. U.S. Installed CHP Sites and Capacity by Prime Mover

Prime Mover	Sites	Share of Sites	Capacity (MW)	Share of Capacity
Reciprocating Engine	2,194	51.9%	2,288	2.7%
Gas Turbine*	667	15.8%	53,320	64.0%
Boiler/Steam Turbine	734	17.4%	26,741	32.1%
Microturbine	355	8.4%	78	0.1%
Fuel Cell	155	3.7%	84	0.1%
Other	121	2.9%	806	1.0%
Total	4,226	100.0%	83,317	100.0%

* includes gas turbine/steam turbine combined cycle

Source: ICF CHP Installation Database, April 2014

All of the technologies described convert a chemical fuel into electric power. The energy in the fuel that is not converted to electricity is released as heat. All of the technologies, except fuel cells, are a class of technologies known as *heat engines*. Heat engines combust the fuel to produce heat, and a portion of that heat is utilized to produce electricity while the remaining heat is exhausted from the process. Fuel cells convert the energy in the fuel to electricity electrochemically; however, there are still inefficiencies in the conversion process that produce heat that can be utilized for CHP. Each technology is described in detail in the individual technology chapters, but a short introduction of each is provided here:

- **Reciprocating engines**, as shown above, make up over half of the CHP systems in place, though, because of the generally smaller system sizes, less than 3 percent of total capacity. The technology is common place – used in automobiles, trucks, trains, emergency power systems, portable power systems, farm and garden equipment. Reciprocating engines can range in size from small hand-held equipment to giant marine engines standing over 5-stories tall and producing the equivalent power to serve 18,000 homes. The technology has been around for more than 100 years. The maturity and high production levels make reciprocating engines a low-cost reliable option. Technology improvements over the last 30 years have allowed this technology to keep pace with the higher efficiency and lower emissions needs of today’s CHP applications. The exhaust heat characteristics of reciprocating engines make them ideal for producing hot water.
- **Steam turbine** systems represent 32 percent of U.S. installed CHP capacity; however, the median age of these installations is 45 years old. Today, steam turbines are mainly used for systems matched to solid fuel boilers, industrial waste heat, or the waste heat from a gas turbine (making it a combined cycle.) Steam turbines offer a wide array of designs and complexity to match the desired application and/or performance specifications ranging from single stage backpressure or condensing turbines for low power ranges to complex multi-stage turbines for higher power ranges. Steam turbines for utility service may have several pressure casings and elaborate design features, all designed to maximize the efficiency of the system. For industrial applications, steam turbines are generally of simpler single casing design and less complicated for reliability and cost reasons. CHP can be adapted to both utility and industrial steam turbine designs.
- **Gas turbines**, as shown, make up over 60 percent of CHP system capacity. It is the same technology that is used in jet aircraft and many *aeroderivative* gas turbines used in stationary

applications are versions of the same engines. Gas turbines can be made in a wide range of sizes from microturbines (to be described separately) to very large *frame* turbines used for central station power generation. For CHP applications, their most economic application range is in sizes greater than 5 MW with sizes ranging into the hundreds of megawatts. The high temperature heat from the turbine exhaust can be used to produce high pressure steam, making gas turbine CHP systems very attractive for process industries.

- **Microturbines**, as already indicated, are very small gas turbines. They were developed as stationary and transportation power sources within the last 30 years. They were originally based on the truck turbocharger technology that captures the energy in engine exhaust heat to compress the engine’s inlet air. Microturbines are clean-burning, mechanically simple, and very compact. There were a large number of competing systems under development throughout the 1990s. Today, following a period of market consolidation, there are two manufacturers in the U.S. providing commercial systems for CHP use with capacities ranging from 30-250 kW for single turbine systems with multiple turbine packages available up to 1,000 kW.
- **Fuel cells** use an electrochemical or battery-like process to convert the chemical energy of hydrogen into water and electricity. In CHP applications, heat is generally recovered in the form of hot water or low-pressure steam (<30 psig) and the quality of heat is dependent on the type of fuel cell and its operating temperature. Fuel cells use hydrogen, which can be obtained from natural gas, coal gas, methanol, and other hydrocarbon fuels. Fuel cells are characterized by the type of electrochemical process utilized, and there are several competing types, phosphoric acid (PAFC), proton exchange membrane (PEMFC), molten carbonate (MCFC), solid oxide (SOFC), and alkaline (AFC). PAFC systems are commercially available in two sizes, 200 kW and 400 kW, and two MCFC systems are commercially available, 300 kW and 1200 kW. Fuel cell capital costs remain high due to low-volume custom production methods, but they remain in demand for CHP applications because of their low air emissions, low-noise, and generous market subsidies.

Table 1-2 and **Table 1-3** provide a summary of the key cost and performance characteristics of the CHP technologies discussed in the CHP Technology Guide.

Table 1-2. Summary of CHP Technology Advantages and Disadvantages

CHP system	Advantages	Disadvantages	Available sizes
Spark ignition (SI) reciprocating engine	<ul style="list-style-type: none"> • High power efficiency with part-load operational flexibility. • Fast start-up. 	<ul style="list-style-type: none"> • High maintenance costs. • Limited to lower temperature cogeneration applications. 	1 kW to 10 MW in DG applications
Compression ignition (CI) reciprocating engine (dual fuel pilot ignition)	<ul style="list-style-type: none"> • Relatively low investment cost. • Has good load following capability. • Can be overhauled on site with normal operators. • Operate on low-pressure gas. 	<ul style="list-style-type: none"> • Relatively high air emissions. • Must be cooled even if recovered heat is not used. • High levels of low frequency noise. 	High speed (1,200 RPM) ≤4MW < 80 MW for Low speed (60-275 RPM)

Table 1-2. Summary of CHP Technology Advantages and Disadvantages

CHP system	Advantages	Disadvantages	Available sizes
Steam turbine	<ul style="list-style-type: none"> • High overall efficiency – steam to power. • Can be mated to boilers firing a variety of gaseous, liquid or solid fuels. • Ability to meet more than one site heat grade requirement. • Long working life and high reliability. • Power to heat ratio can be varied. 	<ul style="list-style-type: none"> • Slow start up. • Very low power to heat ratio. • Requires a boiler or other steam source. 	50 kW to several hundred MWs
Gas turbine	<ul style="list-style-type: none"> • High reliability. • Low emissions. • High grade heat available. • No cooling required. 	<ul style="list-style-type: none"> • Require high pressure gas or in-house gas compressor. • Poor efficiency at low loading. • Output falls as ambient temperature rises. 	500 kW to 300 MW
Microturbine	<ul style="list-style-type: none"> • Small number of moving parts. • Compact size and light weight. • Low emissions. • No cooling required. 	<ul style="list-style-type: none"> • High costs. • Relatively low mechanical efficiency. • Limited to lower temperature cogeneration applications. 	30 kW to 250 kW with multiple unit packages up to 1,000 kW
Fuel cells	<ul style="list-style-type: none"> • Low emissions and low noise. • High efficiency over load range. • Modular design. 	<ul style="list-style-type: none"> • High costs. • Fuels require processing unless pure hydrogen is used. • Sensitive to fuel impurities. • Low power density. 	5 kW to 2 MW

Table 1-3. Comparison of CHP Technology Sizing, Cost, and Performance Parameters

Technology	Recip. Engine	Steam Turbine	Gas Turbine	Microturbine	Fuel Cell
Electric efficiency (HHV)	27-41%	5-40+ ²	24-36%	22-28%	30-63%
Overall CHP efficiency (HHV)	77-80%	near 80%	66-71%	63-70%	55-80%
Effective electrical efficiency	75-80%	75-77%	50-62%	49-57%	55-80%
Typical capacity (MW _e)	.005-10	0.5-several hundred MW	0.5-300	0.03-1.0	200-2.8 commercial CHP
Typical power to heat ratio	0.5-1.2	0.07-0.1	0.6-1.1	0.5-0.7	1-2
Part-load	ok	ok	poor	ok	good
CHP Installed costs (\$/kW _e)	1,500-2,900	\$670-1,100	1,200-3,300 (5-40 MW)	2,500-4,300	5,000-6,500
Non-fuel O&M costs (\$/kW _h _e)	0.009-0.025	0.006 to 0.01	0.009-0.013	0.009-.013	0.032-0.038
Availability	96-98%	72-99%	93-96%	98-99%	>95%
Hours to overhauls	30,000-60,000	>50,000	25,000-50,000	40,000-80,000	32,000-64,000
Start-up time	10 sec	1 hr - 1 day	10 min - 1 hr	60 sec	3 hrs - 2 days
Fuel pressure (psig)	1-75	n/a	100-500 (compressor)	50-140 (compressor)	0.5-45
Fuels	natural gas, biogas, LPG, sour gas, industrial waste gas, manufactured gas	all	natural gas, synthetic gas, landfill gas, and fuel oils	natural gas, sour gas, liquid fuels	hydrogen, natural gas, propane, methanol
Uses for thermal output	space heating, hot water, cooling, LP steam	process steam, district heating, hot water, chilled water	heat, hot water, LP-HP steam	hot water, chiller, heating	hot water, LP-HP steam
Power Density (kW/m ²)	35-50	>100	20-500	5-70	5-20
NO _x (lb/MMBtu) (not including SCR)	0.013 rich burn 3-way cat. 0.17 lean burn	Gas 0.1-.2 Wood 0.2-.5 Coal 0.3-1.2	0.036-0.05	0.015-0.036	0.0025-.0040
NO _x (lb/MWh _{TotalOutput}) (not including SCR)	0.06 rich burn 3-way cat. 0.8 lean burn	Gas 0.4-0.8 Wood 0.9-1.4 Coal 1.2-5.0.	0.52-1.31	0.14-0.49	0.011-0.016

² Power efficiencies at the low end are for small backpressure turbines with boiler and for large supercritical condensing steam turbines for power generation at the high end.

Key comparisons shown in **Table 1-3** are described in more detail below:

- **Electric efficiency** varies by technology and by size with larger systems of a given technology generally more efficient than smaller systems. There is overlap in efficiency ranges among the five technology classes, but, in general, the highest electric efficiencies are achieved by fuel cells, followed by large reciprocating engines, simple cycle gas turbines, microturbines, and then steam turbines. The highest electric efficiencies are achievable by large gas turbines operating in combined cycle with steam turbines that convert additional heat into electricity.
- **Overall CHP efficiency** is more uniform across technology types. One of the key features of CHP is that inefficiencies in electricity generation increase the amount of heat that can be utilized for thermal processes. Therefore, the combined electric and thermal energy efficiency remains in a range of 65-80 percent. The overall efficiency is dependent on the quality of the heat delivered. Gas turbines that deliver high pressure steam for process use have lower overall efficiencies than microturbines, reciprocating engines, and fuel cells that are assumed, in this comparison, to deliver hot water.
- **Installed capital costs** include the equipment (prime mover, heat recovery and cooling systems, fuel system, controls, electrical, and interconnect) installation, project management, engineering, and interest during construction for a simple installation with minimal need for site preparation or additional utilities. The costs are for an average U.S. location; high cost areas would cost more. The lowest unit capital costs are for the established mature technologies (reciprocating engines, gas turbines, steam turbines) and the highest costs are for the two small capacity, newer technologies (microturbines and fuel cells.) Also, larger capacity CHP systems within a given technology class have lower installed costs than smaller capacity systems.
- **Non-fuel O&M costs** include routine inspections, scheduled overhauls, preventive maintenance, and operating labor. As with capital costs, there is a strong trend for unit O&M costs to decline as systems get larger. Among technology classes gas turbines and microturbines have lower O&M costs than comparably sized reciprocating engines. Fuel cells have shown high O&M costs in practice, due in large part to the need for periodic replacement of the expensive stack assembly.
- **Start-up times** for the five CHP technologies described in this Guide can vary significantly. Reciprocating engines have the fastest start-up capability, which allows for timely resumption of the system following a maintenance procedure. In peaking or emergency power applications, reciprocating engines can most quickly supply electricity on demand. Microturbines and gas turbines have a somewhat longer start-up time to “spool-up” the turbine to operating speed. Heat recovery considerations may constrain start-up times for these systems. Steam turbines, on the other hand, require long warm-up periods in order to obtain reliable service and prevent excessive thermal expansion, stress and wear. Fuel cells also have relatively long start-up times (especially for those systems using a high temperature electrolyte.). The longer start-up times for steam turbines and fuel cells make them less attractive for start-stop or load following operation.
- **Availability** indicates the amount of time a unit can be used for electricity and/or steam production. Availability generally depends on the operational conditions of the unit. Measurements of systems in the field have shown that availabilities for gas turbines, steam turbines, and reciprocating engines are typically 95 percent and higher. Early fuel cell and

microturbine installations experienced availability problems; however, commercial units put in service today should also show availabilities over 95 percent.

1.2 CHP Efficiency Compared to Separate Heat and Power

Many of the benefits of CHP stem from the relatively high efficiency of CHP systems compared to other systems. Because CHP systems simultaneously produce electricity and useful thermal energy, CHP efficiency is measured and expressed in a number of different ways.³ A brief discussion of these measures is provided below, while Appendix A provides a more detailed discussion.

The efficiency of electricity generation in power-only systems is determined by the relationship between net electrical output and the amount of fuel used for the power generation. **Heat rate**, the term often used to express efficiency in such power generation systems, is represented in terms of Btus of fuel consumed per kWh of electricity generated. However, CHP plants produce useful heat as well as electricity. In CHP systems, the **total CHP efficiency** seeks to capture the energy content of both electricity and usable steam and is the net electrical output plus the net useful thermal output of the CHP system divided by the fuel consumed in the production of electricity and steam. While total CHP efficiency provides a measure for capturing the energy content of electricity and steam produced it does not adequately reflect the fact that electricity and steam have different qualities. The quality and value of electrical output is higher relative to heat output and is evidenced by the fact that electricity can be transmitted over long distances and can be converted to other forms of energy. To account for these differences in quality, the Public Utilities Regulatory Policies Act of 1978 (PURPA) discounts half of the thermal energy in its calculation of the efficiency standard (Eff_{FERC}). The EFF_{FERC} is represented as the ratio of net electric output plus half of the net thermal output to the total fuel used in the CHP system.

Another definition of CHP efficiency is **effective electrical efficiency**, also known as **fuel utilization effectiveness (FUE)**. This measure expresses CHP efficiency as the ratio of net electrical output to net fuel consumption, where net fuel consumption excludes the portion of fuel that goes to producing useful heat output. FUE captures the value of both the electrical and thermal outputs of CHP plants and it specifically measures the efficiency of generating power through the incremental fuel consumption of the CHP system.

EPA considers fuel savings as the appropriate term to use when discussing CHP benefits relative to separate heat and power (SHP) operations. Fuel savings compares the fuel used by the CHP system to a separate heat and power system (i.e. boiler and electric-only generation). Positive values represent fuel savings while negative values indicate that the CHP system in question is using more fuel than separate heat and power generation.

Figure 1-1 shows the efficiency advantage of CHP compared with conventional central station power generation and onsite boilers. When considering both thermal and electrical processes together, CHP typically requires only $\frac{1}{3}$ the primary energy separate heat and power systems require. CHP systems

³ Measures of efficiency are denoted either as lower heating value (LHV) or higher heating value (HHV). HHV includes the heat of condensation of the water vapor in the products. Unless otherwise noted, all efficiency measures in this section are reported on an HHV basis.

utilize less fuel than separate heat and power generation, resulting for the same level of output, resulting in fewer emissions.

Figure 1-1. CHP versus Separate Heat and Power (SHP) Production⁴

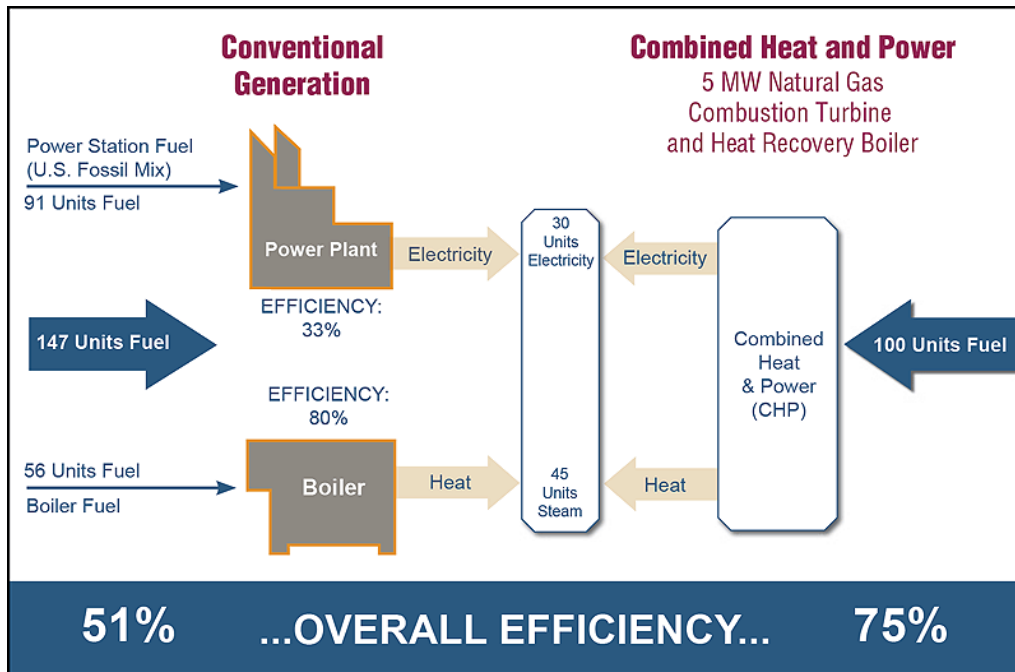

Another important concept related to CHP efficiency is the **power-to-heat ratio**. The power-to-heat ratio indicates the proportion of power (electrical or mechanical energy) to heat energy (steam or hot water) produced in the CHP system. Because the efficiencies of power generation and steam generation are likely to be considerably different, the power-to-heat ratio has an important bearing on how the total CHP system efficiency might compare to that of a separate power-and-heat system. **Figure 1-2** illustrates this point. The figure shows how the overall efficiency might change under alternate power-to-heat ratios for a separate power-and-heat system and a CHP system.

⁴ In this example of a typical CHP system, to produce 75 units of useful energy, the conventional generation or separate heat and power systems use 147 units of energy—91 for electricity production and 56 to produce heat—resulting in an overall efficiency of 51 percent. However, the CHP system needs only 100 units of energy to produce the 75 units of useful energy from a single fuel source, resulting in a total system efficiency of 75 percent.

Figure 1-2. Equivalent Separate Heat and Power Efficiency

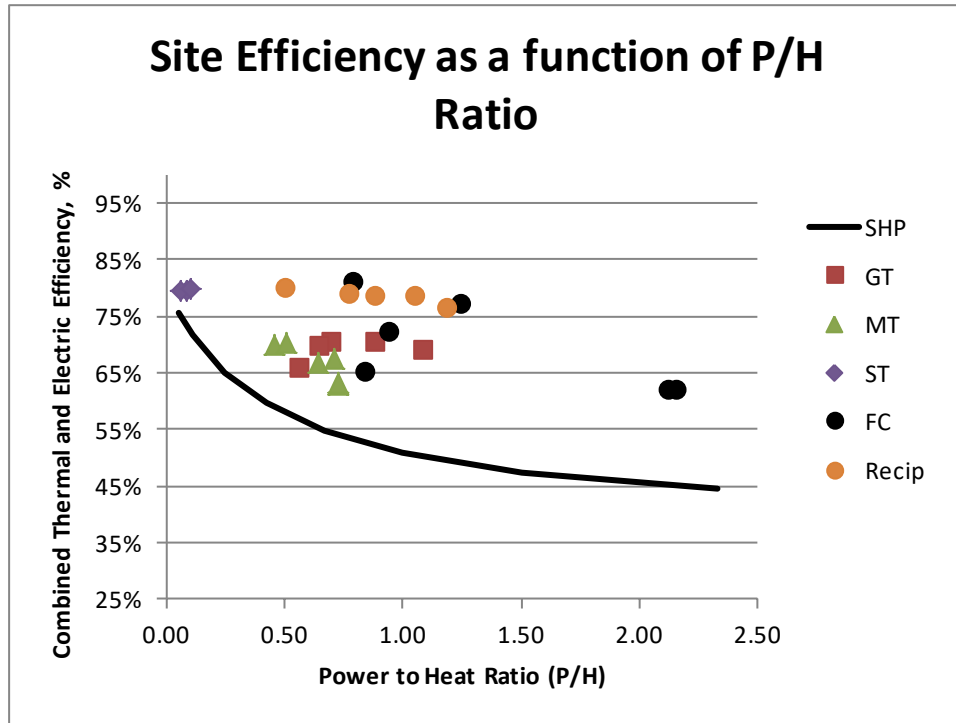

SHP assumes 35.7 percent efficient electric and 80 percent efficient thermal generation

CHP overall thermal and electric efficiencies are higher than corresponding efficiencies for SHP across the range of power-to-heat ratios. However, as shown the SHP efficiency varies as a function of how much of the lower efficiency electricity is supplied versus the higher efficiency thermal energy. At very low power-to-heat ratios, as is typical for steam turbine systems, CHP is above the SHP line, but only by a few percentage points. As electric efficiencies of the CHP systems get higher (and corresponding p/h ratios increase), the relative improvement of CHP compared to SHP increases dramatically.

1.3 Emissions

In addition to cost savings, CHP technologies offer significantly lower emissions rates compared to separate heat and power systems. The primary pollutants from gas turbines are oxides of nitrogen (NO_x), carbon monoxide (CO), and volatile organic compounds (VOCs) (unburned, non-methane hydrocarbons). Other pollutants such as oxides of sulfur (SO_x) and particulate matter (PM) are primarily dependent on the fuel used. Similarly, emissions of carbon dioxide are also dependent on the fuel used. Many gas turbines burning gaseous fuels (mainly natural gas) feature lean premixed burners (also called dry low-NO_x burners) that produce NO_x emissions ranging between 0.17 to 0.25 lbs/MWh⁵ with no post-combustion emissions control. Typically commercially available gas turbines have CO emissions rates ranging between 0.23 lbs/MWh and 0.28 lbs/MWh. Selective catalytic reduction (SCR) or catalytic combustion can further help to reduce NO_x emissions by 80 percent to 90 percent from the gas turbine

⁵ The NO_x emissions reported in this section in lb/MWh are based on the total electric and thermal energy provided by the CHP system in MWh.

exhaust and carbon-monoxide oxidation catalysts can help to reduce CO by approximately 90 percent. Many gas turbines sited in locales with stringent emission regulations use SCR after-treatment to achieve extremely low NO_x emissions.

Microturbines have the potential for low emissions. All microturbines operating on gaseous fuels feature lean premixed (dry low NO_x, or DLN) combustor technology. The primary pollutants from microturbines include NO_x, CO, and unburned hydrocarbons. They also produce a negligible amount of SO₂. Microturbines are designed to achieve low emissions at full load and emissions are often higher when operating at part load. Typical NO_x emissions for microturbine systems range between 4 ppmv and 9 ppmv or 0.08 lbs/MWh and 0.20 lbs/MWh. Additional NO_x emissions removal from catalytic combustion in microturbines is unlikely to be pursued in the near term because of the dry low NO_x technology and the low turbine inlet temperature. CO emissions rates for microturbines typically range between 0.06 lbs/MWh and 0.54 lbs/MWh.

Exhaust emissions are the primary environmental concern with reciprocating engines. The primary pollutants from reciprocating engines are NO_x, CO, and VOCs. Other pollutants such as SO_x and PM are primarily dependent on the fuel used. The sulfur content of the fuel determines emissions of sulfur compounds, primarily SO₂. NO_x emissions from small “rich burn” reciprocating engines with integral 3-way catalyst exhaust treatment can be as low as 0.06 lbs/MWh. Larger lean burn engines have values of around 0.8 lbs/MWh without any exhaust treatment; however, these engines can utilize SCR for NO_x reduction.

Emissions from steam turbines depend on the fuel used in the boiler or other steam sources, boiler furnace combustion section design, operation, and exhaust cleanup systems. Boiler emissions include NO_x, SO_x, PM, and CO. Typical boiler emissions rates for NO_x range between 0.3 lbs/MMBtu and 1.24 lbs/MMBtu for coal, 0.2 lbs/MMBtu and 0.5 lbs/MMBtu for wood, and 0.1 lbs/MMBtu and 0.2 lbs/MMBtu for natural gas. Uncontrolled CO emissions rates range between 0.02 lbs/MMBtu and 0.7 lbs/MMBtu for coal, approximately 0.06 lbs/MMBtu for wood, and 0.08 lbs/MMBtu for natural gas. A variety of commercially available combustion and post-combustion NO_x reduction techniques exist with selective catalytic reductions achieving reductions as high as 90 percent.

Fuel cell systems have inherently low emissions profiles because the primary power generation process does not involve combustion. The fuel processing subsystem is the only significant source of emissions as it converts fuel into hydrogen and a low energy hydrogen exhaust stream. The hydrogen exhaust stream is combusted in the fuel processor to provide heat, achieving emissions signatures of less than 0.019 lbs/MWh of CO, less than 0.016 lbs/MWh of NO_x and negligible SO_x without any after-treatment for emissions. Fuel cells are not expected to require any emissions control devices to meet current and projected regulations.

Other pollutants such as SO_x and PM are primarily dependent on the fuel used. CHP technologies that could use fuels other than natural gas, including reciprocating engines and steam turbines, could also incur other emissions from its fuel choice. For example, the sulfur content of the fuel determines emissions of sulfur compounds, primarily SO₂.

SO₂ emissions from steam turbines depend largely on the sulfur content of the fuel used in the combustion process. SO₂ comprises about 95 percent of the emitted sulfur and the remaining 5 percent is emitted as sulfur tri-oxide (SO₃). Flue gas desulphurization (FGD) is the most commonly used post-combustion SO₂ removal technology and is applicable to a broad range of different uses. FGD can provide up to 95 percent SO₂ removal.

CO₂ emissions result from the use the fossil fuel-based CHP technologies. The amount of CO₂ emitted in any of the CHP technologies discussed above depends on the fuel carbon content and the system efficiency. The fuel carbon content of natural gas is 34 lbs carbon/MMBtu; oil is 48 lbs of carbon/MMBtu and ash-free coal is 66 lbs of carbon/MMBtu.

1.4 Comparison of Water Usage for CHP compared to SHP

Water is critical in all stages of energy production, from drilling for oil and gas to electricity production. As water supply levels are being challenged by continuing and severe droughts, especially in the Southeast and Western regions of the U.S., as well as increasing demand and regulations, water requirements and usage are becoming important considerations in energy production.

According to the U.S. Geological Survey (USGS), thermoelectric power, which uses water for cooling steam turbines, accounts for the largest share of water withdrawal in the U.S., at 49 percent in 2005 (latest year data are available). **Table 1-4** shows the water consumption (gal/MWh) by SHP technology and cooling technology.

Table 1-4. Water Consumption by SHP Technology, Cooling Technology⁶

		Cooling Technologies – Water Consumption (gal/MWh)					
		Open-Loop	Closed-Loop Reservoir	Closed-Loop Cooling Tower	Hybrid Cooling	Air-Cooling	
Fuel Technology	Thermal	Coal	300	385 (±115)	480	between	60 (±10)
		Nuclear	400	625 (±225)	720	between	60 (±10)
		Natural Gas Combustion Turbine	negligible	negligible	negligible	negligible	negligible
		Natural Gas Combined-Cycle	100	130 [†] (±20)	180	between	60 [†] (±10)
		Integrated Gasification Combined-Cycle	not used	not used	350 [†] (±100)	between	60 [†] (±10)
		Concentrated Solar Power	not used	not used	840 (±80)	between	80 [†] (±10)
	Non-Thermal	Wind	none	none	none	none	none
		Photovoltaic Solar	none	none	none	none	none

[†]Estimated based on withdrawal and consumption ratios

⁶ Stillwell, Ashlynn S., et al, *Energy-Water Nexus in Texas*, The University of Texas at Austin and Environmental Defense Fund, April 2009.

The role of CHP technologies could be critical in water issues, as CHP systems, particularly reciprocating engine, combustion turbine, microturbines, and fuel cells, use almost negligible amounts of water. A boiler/steam turbine CHP system water consumption would be similar to the SHP technology shown in **Table 1-4**.

1.5 Outlook

In the last twenty years, there has been substantial improvement in gas turbine technology with respect to power, efficiency, durability, emissions, and time/cost to market. These improvements have been the combined results of collaborative research efforts by private industry, universities, and the federal government. Public-private partnerships such as the DOE Advanced Turbine Systems Program and the Next Generation Turbine program have advanced gas turbine technology. Current collaborative research is focusing on both large gas turbines and those applicable for distributed generation. Large gas turbine research is focused on improving the efficiency of combined cycle plants to 65 percent (LHV), reducing emission even further, and integrating gas turbines with clean coal gasification and carbon capture. The focus for smaller gas turbines is on improving performance, enhancing fuel flexibility, reducing emissions, reducing life cycle costs, and integration with improved thermal utilization technologies. Continued development of aeroderivative gas turbines for civilian and military propulsion will provide carryover benefits to stationary applications. Long-term research includes the development of hybrid gas turbine fuel cell technology that is capable of 70 percent (LHV) electric efficiency.

Microturbine manufacturers are continuing to develop products with higher electrical efficiencies. Working cooperatively with the Department of Energy, Capstone is developing a 250 kW model with a target efficiency of 35 percent (gross output, LHV) and a 370 kW model with a projected 42 percent efficiency. The C250 will feature an advanced aerodynamic compressor design, engine sealing improvements, improved generator design with longer life magnet, and enhanced cooling. The project will use a modified Capstone C200 turbocompressor assembly as the low-pressure section of a two shaft turbine. This low-pressure section will have an electrical output of 250 kW. A new high-temperature, high-pressure turbocompressor assembly will increase the electrical output to 370 kW. Product development in microturbines over the years has been to achieve efficiency and cost reductions by increasing the capacity of the products. Starting with original products in the 30-50 kW range, microturbine manufacturers have developed and are continuing to develop increasingly larger products that compete more directly with larger reciprocating gas engines and even small simple cycle gas turbines.

Public-private partnerships such as the DOE Advanced Reciprocating Engine System (ARES) funded by DOE and the Advanced Reciprocating Internal Combustion Engine (ARICE) program funded by the California Energy Commission have focused attention on the development of the next generation reciprocating engine. The original goals of the ARES program were to achieve 50 percent brake thermal efficiency (LHV), NO_x emissions to less than 1 g/bhp-hr (0.3 lb/MWh), and maintenance costs of \$0.01/kWh, all while maintaining cost competitiveness. The development focus under ARES includes:

- Combustion chamber design
- Friction reduction
- Combustion of dilute mixtures

- Turbocompounding
- Modified or alternative engine cycles
- Exhaust energy retention
- Exhaust after-treatment – improving SCR and TWC operation and proving the operation of Lean NO_x catalyst (LNC)
- Water injection
- High power density
- Multiple source ignition

The U.S. DOE funds collaborative research and development toward the development of improved ultra-supercritical (USC) steam turbines capable of efficiencies of 55-60 percent that are based on boiler tube materials that can withstand pressures of up to 5,000 psi and temperatures of 1,400 °F. To achieve these goals, work is ongoing in materials, internal design and construction, steam valve development, and design of high pressure casings. A prototype is targeted for commercial testing by 2025. Research is also underway to restore and improve the performance of existing steam turbines in the field through such measures as improved combustion systems for boilers, heat transfer and aerodynamics to improve turbine blade life and performance, and improved materials to permit longer life and higher operating temperatures for more efficient systems.

The focus on emerging markets such as waste heat recovery and biomass-fueled power and CHP plants is stimulating the demand for small and medium steam turbines. Technology and product development for these markets should bring about future improvements in steam turbine efficiency, longevity, and cost. This could be particularly true for systems below 500 kW that are used in developmental small biomass systems and in waste-heat-to-power systems designed to operate in place of pressure reduction valves in commercial and industrial steam systems operating at multiple pressures.

Section 2. Technology Characterization – Reciprocating Internal Combustion Engines

2.1 Introduction

Reciprocating internal combustion engines are a well-established and widely used technology. Worldwide production for reciprocating internal combustion engines is over 200 million units per year.⁷ Reciprocating engines include both diesel and spark-ignition configurations. They are important for both transportation and for stationary uses. Their sizes range from fractional horsepower engines to 5-story tall marine propulsion systems weighing over 5 million pounds and producing over 80 megawatts (MW) of power. The long history of technical development and high production levels have contributed to making reciprocating engines a rugged, reliable, and economic choice as a prime mover for CHP applications.

Reciprocating engine technology has improved dramatically over the past three decades, driven by economic and environmental pressures for power density improvements (more output per unit of engine displacement), increased fuel efficiency, and reduced emissions. Electronic Power Control Modules (PCMs) have made possible more precise control and diagnostic monitoring of the engine process. Stationary engine manufacturers and worldwide engine R&D firms continue to drive advanced engine technology, including accelerating the diffusion of innovative technology and concepts from the automotive market to the stationary market.

The features that have made reciprocating engines a leading prime mover for CHP and other distributed generation applications are summarized in **Table 2-1**.

Table 2-1. Reciprocating Engine Characteristics

Size range	Reciprocating engines are available in sizes from 10 kW to over 18 MW.
Thermal output	Reciprocating engines can produce hot water, low pressure steam, and chilled water (using an absorption chiller).
Fast start-up	The fast start-up capability of reciprocating engines allows timely resumption of the system following a maintenance procedure. In peaking or emergency power applications, reciprocating engines can quickly supply electricity on demand.
Black-start capability	In the event of an electric utility outage, reciprocating engines require minimal auxiliary power requirements. Generally only batteries or compressed air are required.
Availability	Reciprocating engines have typically demonstrated availability in excess of 95 percent in stationary power generation applications.
Part-load operation	The high part-load efficiency of reciprocating engines ensures economical operation in electric load following applications.
Reliability and life	Reciprocating engines have proven to be reliable power generators given proper maintenance.
Emissions	Diesel engines have relatively high emissions levels of NO _x and particulates. However, natural gas spark ignition engines have improved emissions profiles.

⁷ Power Systems Research, EnginLinkTM 2013

2.2 Applications

Reciprocating engines are well suited to a variety of distributed generation applications, and are used throughout industrial, commercial, and institutional facilities for power generation and CHP.

Reciprocating engines start quickly, follow load well, have good part load efficiencies, and generally have high reliabilities. In many cases, having multiple reciprocating engine units further increases overall plant capacity and availability. Reciprocating engines have higher electrical efficiencies than gas turbines of comparable size, and thus lower fuel-related operating costs. In addition, the upfront costs of reciprocating engine gensets are generally lower than gas turbine gensets in sizes below 20 MW. Reciprocating engine maintenance costs are generally higher than comparable gas turbines, but the maintenance can often be handled by in-house staff or provided by local service organizations.

2.2.1 Combined Heat and Power

There are over 2,000 active reciprocating engine combined heat and power (CHP) installations in the U.S. providing nearly 2.3 gigawatts (GW) of power capacity⁸. These systems are predominantly spark ignition engines fueled by natural gas and other gaseous fuels (biogas, landfill gas). Natural gas is lower in cost than petroleum based fuels and emissions control is generally more effective using gaseous fuels. Reciprocating engine CHP systems are commonly used in universities, hospitals, water treatment facilities, industrial facilities, and commercial and residential buildings. Facility capacities range from 30 kW to 30 MW, with many larger facilities comprised of multiple units. Spark ignited engines fueled by natural gas or other gaseous fuels represent 84 percent of the installed reciprocating engine CHP capacity.

Thermal loads most amenable to engine-driven CHP systems in commercial/institutional buildings are space heating and hot water requirements. The simplest thermal load to supply is hot water. The primary applications for CHP in the commercial/institutional and residential sectors are those building types with relatively high and coincident electric and hot water demand such as colleges and universities, hospitals and nursing homes, multifamily residential buildings, and lodging. If space heating needs are incorporated, office buildings, and certain warehousing and mercantile/service applications can be economical applications for CHP. Technology development efforts targeted at heat activated cooling/refrigeration and thermally regenerated desiccants expand the application of engine-driven CHP by increasing the thermal energy loads in certain building types. Use of CHP thermal output for absorption cooling and/or desiccant dehumidification could increase the size and improve the economics of CHP systems in already strong CHP markets such as schools, multifamily residential buildings, lodging, nursing homes and hospitals. Use of these advanced technologies in other sectors such as restaurants, supermarkets and refrigerated warehouses provides a base thermal load that opens these sectors to CHP application.

Reciprocating engine CHP systems usually meet customer thermal and electric needs as in the two hypothetical examples below:

- A typical commercial application for reciprocating engine CHP is a hospital or health care facility with a 1 MW CHP system comprised of multiple 200 to 300 kW natural gas engine gensets. The

⁸ ICF CHP Installation Database. Maintained for Oak Ridge National Laboratory by ICF International. 2013. <http://www.eea-inc.com/chpdata/index.html>

system is designed to satisfy the baseload electric needs of the facility. Approximately 1.6 MW of thermal energy (MW_{th}), in the form of hot water, is recovered from engine exhaust and engine cooling systems to provide space heating and domestic hot water to the facility as well as to drive absorption chillers for space conditioning during summer months. Overall efficiency of this type of CHP system can exceed 70 percent.

- A typical industrial application for engine CHP would be a food processing plant with a 2 MW natural gas engine-driven CHP system comprised of multiple 500 to 800 kW engine gensets. The system provides baseload power to the facility and approximately 2.2 MW_{th} low pressure steam for process heating and washdown. Overall efficiency for a CHP system of this type approaches 75 percent.

2.2.2 Emergency/Standby Generators

Reciprocating engine emergency/standby generators are used in a wide variety of settings from residential homes to hospitals, scientific laboratories, data centers, telecommunication equipment, and modern naval ships. Residential systems include portable gasoline fueled spark-ignition engines or permanent installations fueled by natural gas or propane. Commercial and industrial systems more typically use diesel engines. The advantages of diesel engines in standby applications include low upfront cost, ability to store on-site fuel if required for emergency applications, and rapid start-up and ramping to full load. Because of their relatively high emissions of air pollutants, such diesel systems are generally limited in the number of hours they can operate. These systems may also be restricted by permit from providing any other services such as peak-shaving.

2.2.3 Peak Shaving

Engine generators can supply power during utility peak load periods thereby providing benefits to both the end user and the local utility company. The facility can save on peak power charges and the utility can optimize operations and minimize investments in generation, transmission, and distribution that are used only 0-200 hours/year. In a typical utility peak shaving program, a utility will ask a facility to run its on-site generator during the utility's peak load period, and in exchange, the utility will provide the facility with monthly payments.

2.3 Technology Description

2.3.1 Basic Processes

There are two primary reciprocating engine designs relevant to stationary power generation applications – the spark ignition Otto-cycle engine and the compression ignition Diesel-cycle engine. The essential mechanical components of the Otto-cycle and Diesel-cycle are the same. Both use a cylindrical combustion chamber in which a close fitting piston travels the length of the cylinder. The piston connects to a crankshaft that transforms the linear motion of the piston into the rotary motion of the crankshaft. Most engines have multiple cylinders that power a single crankshaft.

The main difference between the Otto and Diesel cycles is the method of igniting the fuel. Spark ignition engines (Otto-cycle) use a spark plug to ignite a pre-mixed air fuel mixture introduced into the cylinder. Compression ignition engines (Diesel-cycle) compress the air introduced into the cylinder to a high

pressure, raising its temperature to the auto-ignition temperature of the fuel that is injected at high pressure.

Engines are further categorized by crankshaft speed in revolutions per minute (rpm), operating cycle (2- or 4-stroke), and whether turbocharging is used. Reciprocating engines are also categorized by their original design purpose, such as automotive, truck, industrial, locomotive and marine. Hundreds of small-scale stationary power, CHP, irrigation, and chiller applications use automotive engine models. These are generally low-priced engines due to the economies of scale of large production volumes. Truck engines have the cost benefit of production volume and are designed for a reasonably long life (e.g., one million miles). A number of truck engines are available as stationary engines. Engines intended for industrial use are designed for durability and for a wide range of mechanical drive and electric power applications. Their sizes range from 20 kW up to 6 MW, including industrialized truck engines in the 200 to 600 kW range and industrially applied marine and locomotive engines above 1 MW.

There are 2-cycle engines in stationary power applications, particularly in standby service. However, most spark ignition and the diesel engines relevant to stationary power generation applications complete a power cycle in four strokes of the piston within the cylinder as shown in **Figure 2-1**.

1. **Intake stroke** – introduction of air (diesel) or air-fuel mixture (spark ignition) into the cylinder.
2. **Compression stroke** – compression of air or an air-fuel mixture within the cylinder. In diesel engines, the fuel is injected at or near the end of the compression stroke (top dead center or TDC), and ignited by the elevated temperature of the compressed air in the cylinder. In spark ignition engines, the compressed air-fuel mixture is ignited by an ignition source at or near TDC.
3. **Power stroke** – acceleration of the piston by the expansion of the hot, high pressure combustion gases.
4. **Exhaust stroke** – expulsion of combustion products from the cylinder through the exhaust port.

Figure 2-1. 4-Stroke Reciprocating Engine Cycle

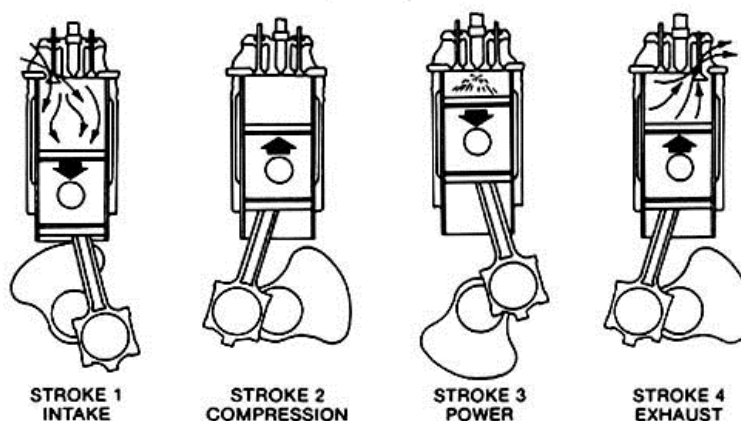

Source: http://www.globalspec.com/learnmore/motion_controls/engines_components/industrial_engines

2.3.2 Components

2.3.2.1 Engine System

Natural Gas Spark Ignition Engines

Current natural gas engines for power generation offer low first cost, fast start-up, proven reliability when properly maintained, excellent load-following characteristics, and significant heat recovery potential. Electric efficiencies of natural gas engines range from 30 percent LHV (27 percent HHV) for small stoichiometric engines (<100 kW) to over 46 percent LHV (42 percent HHV) for large lean burn engines (> 3 MW).^{9,10} Waste heat recovered from the hot engine exhaust and from the engine cooling systems produces either hot water or low pressure steam for CHP applications. Overall CHP system efficiencies (electricity and useful thermal energy) of up to 80 percent (HHV) can be achieved.

Spark ignition engines use spark plugs, with a high-intensity spark of timed duration, to ignite a compressed fuel-air mixture within the cylinder. Natural gas is the predominant spark ignition engine fuel used in electric generation and CHP applications. Other gaseous and volatile liquid fuels, ranging from landfill gas to propane to gasoline, can be used with the proper fuel system, engine compression ratio, and tuning. American manufacturers began to develop large natural gas engines for the burgeoning gas transmission industry after World War II. Smaller engines were developed (or converted from diesel blocks) for gas gathering and other stationary applications as the natural gas infrastructure developed. Natural gas engines for power generation applications are primarily 4-stroke engines, available in sizes up to about 18 MW.

Depending on the engine size, one of two ignition techniques ignites the natural gas:

- **Open chamber** – the spark plug tip is exposed in the combustion chamber of the cylinder, directly igniting the compressed fuel-air mixture. Open chamber ignition is applicable to any engine operating near the stoichiometric air/fuel ratio for up to moderately lean mixtures.¹¹
- **Precombustion chamber** – a staged combustion process where the spark plug is housed in a small chamber mounted on the cylinder head. This cylinder is charged with a rich mixture of fuel and air, which upon ignition shoots into the main combustion chamber in the cylinder as a high energy torch. This technique provides sufficient ignition energy to light off very lean fuel-air mixtures used in large bore engines.¹²

The simplest natural gas engines operate with a natural aspiration of air and fuel into the cylinder (via a carburetor or other mixer) by the suction of the intake stroke. High performance natural gas engines are

⁹ The exact ratio of air to fuel that is required for complete combustion is called the stoichiometric ratio. If there is less or more air than needed for complete combustion the engine is called rich burn or lean burn respectively.

¹⁰ Most efficiencies quoted in this report are based on higher heating value (HHV), which includes the heat of condensation of the water vapor in the combustion products. In engineering and scientific literature the lower heating value (LHV – which does not include the heat of condensation of the water vapor in the combustion products) is often used. The HHV is greater than the LHV by approximately 10% with natural gas as the fuel (i.e., 50% LHV is equivalent to 45% HHV). Higher Heating Values are about 6% greater for oil (liquid petroleum products) and 5% for coal.

¹¹ Stoichiometric ratio is the chemically correct ratio of fuel to air for complete combustion, i.e., there is no unused fuel or oxygen after combustion.

¹² Lean mixture is a mixture of fuel and air in which an excess of air is supplied in relation to the amount needed for complete combustion; similarly, a rich mixture is a mixture of fuel and air in which an excess of fuel is supplied in relation to the amount needed for complete combustion.

turbocharged to force more air into the cylinders. Natural gas spark ignition engines operate at modest compression ratios (compared with diesel engines) in the range of 9:1 to 12:1 depending on engine design and turbocharging.

Using high energy ignition technology, very lean fuel-air mixtures can be burned in natural gas engines, lowering peak temperatures within the cylinders, and resulting in reduced NO_x emissions. The lean burn approach in reciprocating engines is analogous to dry low-NO_x combustors in gas turbines. All major natural gas engine manufacturers offer lean burn, low emission models and are engaged in R&D to further improve their performance.

Natural gas spark ignition engine efficiencies are typically lower than diesel engines because of their lower compression ratios. However, large, high performance lean burn engine efficiencies can exceed those of diesel engines of the same size. Natural gas engine efficiencies range from about 28 percent (LHV) for small engines (<50 kW) to 46 percent (LHV) for the largest high performance, lean burn engines. Lean burn engines tuned for maximum efficiency may produce twice the NO_x emissions as the same engine tuned for minimum NO_x. Tuning for low NO_x typically results in a sacrifice of 1 to 1.5 percentage points in electric generating efficiency from the highest level achievable.

Many natural gas spark ignition engines are derived from diesel engines (i.e., they use the same block, crankshaft, main bearings, camshaft, and connecting rods as the diesel engine). However, natural gas spark ignition engines operate at lower brake mean effective pressure (BMEP) and peak pressure levels to prevent knock.¹³ Due to the derating effects from lower BMEP, the spark ignition versions of smaller diesel engines may produce only 60 to 80 percent of the power output of the parent diesel. Manufacturers often enlarge cylinder bore by about 5 to 10 percent to increase the power to levels which meet or exceed their diesel counterparts. The \$/kW capital costs of large, high performance natural gas spark ignition engines are typically on a similar level to the diesel engines from which they were derived. However, by operating at lower cylinder pressure and bearing loads as well as in the cleaner combustion environment of natural gas, spark ignition engines generally offer the benefits of extended component life compared to their diesel parents.

2.3.2.2 Diesel Engines

Diesel engines have historically been the most common type of reciprocating engine for both small and large power generation applications. However, in the United States and other industrialized nations, diesel engines are increasingly restricted to emergency standby or limited duty-cycle service because of air emission concerns and also because of the high cost of fuel. Consequently, the natural gas-fueled SI engine is now the engine of choice for the higher duty cycle stationary power market (over 500 hr/yr) and is the primary focus of this report.

Compression ignition diesel engines are among the most efficient simple-cycle power generation options on the market. Efficiency levels increase with engine size and range from about 30 percent (HHV) for small high-speed diesels up to 42 to 48 percent (HHV) for the large bore, slow speed engines. High speed diesel engines ($\geq 1,000$ rpm) are available for up to about 4 MW in size. Low speed diesel

¹³ Brake mean effective pressure (BMEP) can be regarded as the “average” cylinder pressure on the piston during the power stroke and is a measure of the effectiveness of engine power output or mechanical efficiency.

engines (60 to 275 rpm) are available as large as 80 MW. Medium speed diesel engines (400 – 1000 rpm) are available for up to approximately 17 MW.

Diesel engines typically require compression ratios of 12:1 to 17:1 to heat the cylinder air to a temperature at which the injected fuel will ignite. The quality of fuel injection significantly affects diesel engine operating characteristics, fuel efficiency, and emissions. Fine atomization and good fuel dispersion by the injectors are essential for rapid ignition, ideal combustion and emissions control. Manufacturers are increasingly moving toward electronically controlled, high pressure injection systems that provide more precise calibration of fuel delivery and accurate injection timing.

Depending on the engine and fuel quality, diesel engines produce 5 to 20 times the NO_x (on a ppmv basis) of a lean burn natural gas engine. Diesel engines on marine engines often emit over 20 lbs NO_x/MWh and present on road engines emit less than 13 lbs NO_x/MWh. New diesel engines will achieve rates of approximately 0.65 lb NO_x/MWh. Diesel engines also produce assorted heavy hydrocarbons and particulate emissions. However, diesel engines produce significantly less CO than lean burn gas engines. The NO_x emissions from diesels burning heavy oil are typically 25 to 30 percent higher than diesels using distillate oil. Common NO_x control techniques include delayed fuel injection, exhaust gas recirculation, water injection, fuel-water emulsification, inlet air cooling, intake air humidification, and compression ratio and/or turbocharger modifications. In addition, an increasing number of larger diesel engines are equipped with selective catalytic reduction and oxidation catalyst systems for post-combustion emissions reduction.

High speed diesel engines generally require high quality fuel oil with good combustion properties. No. 1 and No. 2 distillate oil comprise the standard diesel fuels. Ultra-low sulfur diesel with sulfur contents of less than 0.15 ppm is now required for the new Tier 4 diesel engines to reduce sulfur emissions. High speed diesel engines are not suited to burning oil heavier than distillate. Heavy fuel oil requires more time for combustion and the combination of high speed and contaminants in lower quality heavy oils cause excessive wear in high speed diesel engines. Many medium and low speed diesel designs burn heavier oils including low grade residual oils or Bunker C oils.

2.3.2.3 Dual Fuel Engines

Dual fuel engines are predominantly fueled by natural gas with a small percentage of diesel oil added. There are two main configurations for introducing the gaseous fuel in a dual fuel engine. These engines can be purpose built or conversions of diesel engines. Such engines can be switched to 100 percent diesel operation. Dual fuel engines provide a multi-use functionality. Operation on predominantly cheaper and cleaner burning natural gas allows the engine to be used in CHP and peak shaving applications, while operation on 100 percent diesel allows the engine to also meet the onsite fuel requirements of emergency generators. The dual function adds benefit in applications that have specific emergency generator requirements such as in hospitals or in public buildings.

There are three main configurations for introducing the gaseous and pilot diesel fuel: 1) low pressure injection with the intake air, 2) high pressure injection after the intake air has been compressed by the piston, and 3) micropilot prechamber introduction of the diesel fuel. New dual-fuel engines are offered in oil and gas production markets to reduce operating costs. Dual-fuel retrofits of existing diesel engines are also offered as a means to reduce both operating costs and emissions for extending the hours of use

for limited duty engines such as emergency and peaking applications. Dual fuel is not widely used for CHP applications.

2.3.2.4 Heat Recovery

The economics of engines in on-site power generation applications often depend on effective use of the thermal energy contained in the exhaust gas and cooling systems, which generally represents 60 to 70 percent of the inlet fuel energy. Most of the waste heat is available in the engine exhaust and jacket coolant, while smaller amounts can be recovered from the lube oil cooler and the turbocharger's intercooler and aftercooler (if so equipped). As shown in the previous table, 45 to 55 percent of the waste heat from engine systems is recovered from jacket cooling water and lube oil cooling systems at a temperature too low to produce steam. This feature is generally less critical in commercial/institutional applications where it is more common to have hot water thermal loads. Steam can be produced from the exhaust heat if required (maximum pressure of 400 psig), but if no hot water is needed, the amount of heat recovered from the engine is reduced and total CHP system efficiency drops accordingly.

Heat in the engine jacket coolant accounts for up to 30 percent of the energy input and is capable of producing 190 to 230 °F hot water. Some engines, such as those with high pressure or ebullient cooling systems, can operate with water jacket temperatures of up to 265°F. Engine exhaust heat represents 30 to 50 percent of the available waste heat. Exhaust temperatures for the example systems range from 720 to 1000°F. By recovering heat in the cooling systems and exhaust, around 80 percent of the fuel's energy can be effectively utilized to produce both power and useful thermal energy.

Closed-loop cooling systems – The most common method of recovering engine heat is the closed-loop cooling system as shown in **Figure 2-2**. These systems are designed to cool the engine by forced circulation of a coolant through engine passages and an external heat exchanger. An excess heat exchanger transfers engine heat to a cooling tower or a radiator when there is excess heat generated. Closed-loop water cooling systems can operate at coolant temperatures from 190 to 250°F. Depending on the engine and CHP system's requirements, the lube oil cooling and turbocharger after-cooling may be either separate or part of the jacket cooling system.

Figure 2-2. Closed-Loop Heat Recovery System

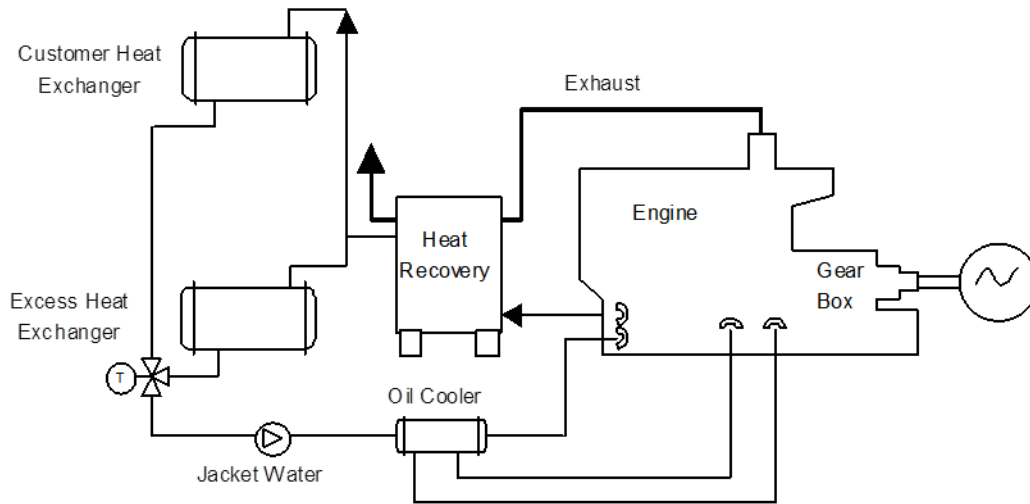

Ebullient Cooling Systems – Ebullient cooling systems cool the engine by natural circulation of a boiling coolant through the engine. This type of cooling system is typically used in conjunction with exhaust heat recovery for production of low-pressure steam. Cooling water is introduced at the bottom of the engine where the transferred heat begins to boil the coolant generating two-phase flow. The formation of bubbles lowers the density of the coolant, causing a natural circulation to the top of the engine.

The coolant at the engine outlet is maintained at saturated steam conditions and is usually limited to 250°F and a maximum of 15 psig. Inlet cooling water is also near saturation conditions and is generally 2 to 3°F below the outlet temperature. The uniform temperature throughout the coolant circuit extends engine life and contributes to improved combustion efficiencies.

Exhaust Heat Recovery – Exhaust heat is typically used to generate hot water of up to about 230°F or steam up to 400 psig. Only a portion of the exhaust heat can be recovered since exhaust gas temperatures are generally kept above temperature thresholds to prevent the corrosive effects of condensation in the exhaust piping. For this reason, most heat recovery units are designed for a 250 to 350°F exhaust outlet temperature.

Exhaust heat recovery can be independent of the engine cooling system or coupled with it. For example, hot water from the engine cooling can be used as feedwater or feedwater preheat to the exhaust recovery unit. In a typical district heating system, jacket cooling, lube oil cooling, single stage aftercooling, and exhaust gas heat recovery are all integrated for steam production.

2.4 Performance Characteristics

Table 2-2 summarizes performance characteristics for typical commercially available natural gas spark ignition engine CHP systems over a 100 kW to 9 MW size range. This size range covers the majority of the market applications for engine-driven CHP. Heat rates and efficiencies shown were taken from manufacturers' specifications and industry publications. Available thermal energy was taken directly from vendor specifications or, if not provided, calculated from published engine data on engine exhaust

temperatures and engine jacket and lube system coolant flows. CHP thermal recovery estimates are based on producing hot water for process or space heating needs.

Most reciprocating engine manufacturers typically assign three power ratings to engines depending on the intended load service:

- **Standby** – continuous full or cycling load for a relatively short duration (usually less than 100 hours) – *maximum power output rating*
- **Prime** – continuous operation for an unlimited time (except for normal maintenance shutdowns), but with regular variations in load – *80 to 85 percent of the standby rating*
- **Baseload** – continuous full-load operation for an unlimited time (except for normal maintenance shutdowns) – *70 to 75 percent of the standby rating.*

The ratings shown are for baseload operation.

Table 2-2. Gas Spark Ignition Engine CHP - Typical Performance Parameters

Cost & Performance Characteristics ¹⁴	System				
	1	2	3	4	5
Baseload Electric Capacity (kW)	100	633	1,121	3,326	9,341
Total Installed Cost in 2013 (\$/kW) ¹⁵	\$2,900	\$2,837	\$2,366	\$1,801	\$1,433
Electrical Heat Rate (Btu/kWh), HHV ¹⁶	12,637	9,896	9,264	8,454	8,207
Electrical Efficiency (%), HHV	27.0%	34.5%	36.8%	40.4%	41.6%
Engine Speed (rpm)	2,500 ¹⁷	1,800	1,800	1,500 ¹⁸	720
Fuel Input (MMBtu/hr), HHV	1.26	6.26	10.38	28.12	76.66
Required Fuel Gas Pressure (psig)	0.4-1.0	> 1.16	> 1.74	> 1.74	75
CHP Characteristics					
Exhaust Flow (1000 lb/hr)	1.2	7.89	13.68	40.17	120
Exhaust Temperature (Fahrenheit)	1,200	941	797	721	663
Heat Recovered from Exhaust (MMBtu/hr)	0.21	1.48	2	5.03	10
Heat Recovered from Cooling Jacket (MMBtu/hr)	0.46	0.72	1.29	1.63	4.27
Heat Recovered from Lube System (MMBtu/hr)	Incl.	0.27	0.44	1.12	5.0
Heat Recovered from Intercooler (MMBtu/hr)	n/a	0.31	0.59	2.89	7.54
Total Heat Recovered (MMBtu/hr)	0.67	2.78	4.32	10.67	26.81
Total Heat Recovered (kW)	196	815	1,266	3,126	7857

¹⁴ Characteristics are for representative natural gas engine gensets commercially available in 2013. Data based on (1) Tecogen Inverde Ultra 100, (2) GE Jenbacher (GEJ) JMS-312C65; (3) GEJ JMS-416B85, (4) GEJ JMS-620F01, and (5) Wartsila 20V34SG

¹⁵ Details on installed costs are provided later in **Table 2-4**.

¹⁶ All engine manufacturers quote heat rates in terms of the lower heating value (LHV) of the fuel. However the purchase price of fuels on an energy basis is measured on a higher heating value basis (HHV). For natural gas, the average heat content is 1030 Btu/scf on an HHV basis and 930 Btu/scf on an LHV basis – a ratio of approximately 0.9 (LHV / HHV).

¹⁷ At rated load. The unit operates at variable speeds from 1,000 to 3,000 rpm, with a peak output of 125 kW while producing 60 Hz power through the inverter.

¹⁸ The unit operates through a gearbox to produce 60 Hz power.

Table 2-2. Gas Spark Ignition Engine CHP - Typical Performance Parameters

Cost & Performance Characteristics ¹⁴	System				
	1	2	3	4	5
Form of Recovered Heat	H ₂ O	H ₂ O	H ₂ O	H ₂ O	H ₂ O, steam
Total Efficiency [%] ¹⁹	80.0%	78.9%	78.4%	78.3%	76.5%
Thermal Output / Fuel Input [%]	53.0%	44.4%	41.6%	37.9%	35.0%
Power / Heat Ratio ²⁰	0.51	0.78	0.89	1.06	1.19

Source: Compiled by ICF from vendor supplied data.

The data in the table show that electrical efficiency increases as engine size becomes larger. As electrical efficiency increases, the absolute quantity of thermal energy available to produce useful thermal energy decreases per unit of power output, and the ratio of power to heat for the CHP system generally increases. A changing ratio of power to heat impacts project economics and may affect the decisions that customers make in terms of CHP acceptance, sizing, and the desirability of selling power.

2.4.1 Part Load Performance

In power generation and CHP applications, reciprocating engines generally drive synchronous generators at constant speed to produce steady alternating current (AC) power. As load is reduced, the heat rate of spark ignition engines increases and efficiency decreases. **Figure 2-3** shows the part load efficiency curve for a typical lean burn natural gas engine. The efficiency at 50 percent load is approximately 8 to 10 percent less than full load efficiency. As the load decreases further, the curve becomes somewhat steeper. While gas engines compare favorably to gas turbines, which typically experience efficiency decreases of 15 to 25 percent at half load conditions, multiple engines may be preferable to a single large unit to avoid efficiency penalties where significant load reductions are expected on a regular basis. Diesel engines exhibit even more favorable part load characteristics than spark ignition engines. The efficiency curve for diesel engines is comparatively flat between 50 and 100 percent load.

¹⁹ Total CHP Efficiency = (net electric generated + net thermal energy recovered)/total engine fuel input.

²⁰ Power/Heat Ratio = (CHP electric power output (Btus))/useful thermal output (Btus)

Figure 2-3. Part Load Generator Terminal Efficiency, System 5

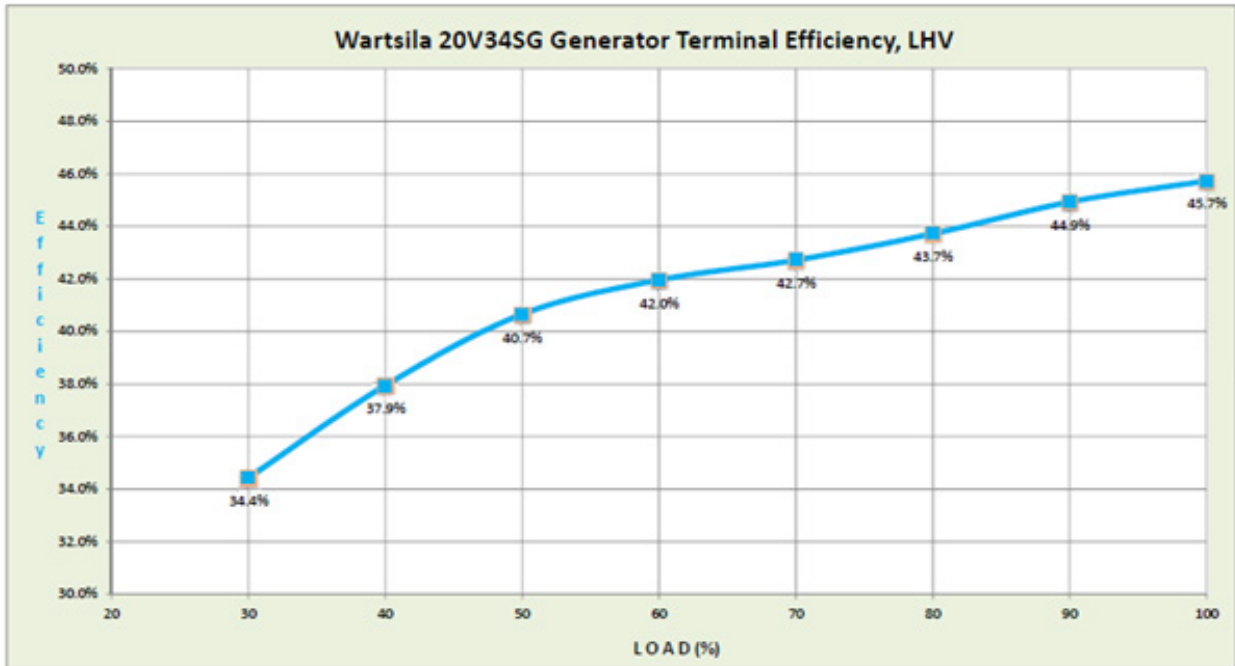

Source: Wartsila²¹

2.4.2 Effects of Ambient Conditions on Performance

Reciprocating engines are generally rated at ISO conditions of 77 °F and 0.987 atmospheres (1 bar) pressure. (Gas turbines are rated at 59 °F.) Like gas turbines, reciprocating engine performance – measured for both output and efficiency – degrades as ambient temperature or site elevation increases. While the effect on gas turbines can be significant, it is less so on engines. Reciprocating engine efficiency and power are reduced by approximately 4 percent per 1,000 feet of altitude above 1,000 feet, and about 1 percent for every 10°F above 77°F.

2.4.3 Engine Speed Classifications

Reciprocating engines are classified as high-, medium-, or low-speed. **Table 2-3** presents the standard speed ranges in each class and the types and sizes of engines available. Engine driven electric generators typically must run at fixed (or synchronous) speeds to maintain a constant 50 or 60 Hertz (Hz) output, setting the engine speed needed within the classifications (i.e., a 60 Hz generator driven by a high speed engine would require engine speeds of 1200, 1800 or 3600 rpm versus a 50 Hz generator which requires engine speeds of 1000, 1500 or 3000 rpm).

²¹ Wartsila gas-fired engines. <http://www.wartsila.com/en/power-plants/technology/combustion-engines/gas-engines>.

Table 2-3. Reciprocating Engine Types by Speed (Available MW Ratings)

Speed Classification	Engine Speed	Stoic/Rich Burn, Spark Ignition ²²	Lean Burn, Spark Ignition	Dual Fuel	Diesel
High Speed	1000-3600 rpm	0.01 – 1.5 MW	0.15 - 3.0 MW	1.0 - 3.5 MW ²³	0.01 – 3.5 MW
Medium Speed	275-1000 rpm	None	1.0 – 18 MW	1.0 – 17 MW	0.5 – 18 MW
Low Speed	58-275 rpm	None	None	2.0 – 65 MW	2 – 84 MW

Source: SFA Pacific, Inc., Wartsila

Engine power output is partly proportional to engine speed, which affords high speed engines the highest output per unit of displacement (cylinder size) and the highest power density. Consequently, high speed engines generally have the lowest \$/kW production costs of the three types. The cost benefits of high speed engines must be weighed against other factors. Smaller high speed engines have lower efficiencies than large bore, lower speed engines due in part to the higher surface area to volume ratio for small cylinders resulting in slightly higher heat losses. In addition, higher speed engines tend to have higher wear rates, resulting in shorter periods between minor and major overhauls. These factors are often less important than capital costs for limited duty cycle applications.

Medium speed stationary power engines are largely derived from marine and locomotive engines. Medium speed engines are higher in cost, but generally higher in efficiency than high speed engines. Because of their massive physical size and high cost of installation, low speed engines are increasingly being displaced by medium and high speed engines as the primary choice for stationary power applications; with low speed engines being left to their primary market as marine propulsion engines.

Most reciprocating engine manufacturers typically assign three power ratings to engines depending on the intended load service:

- **Standby** - continuous full or cycling load for a relatively short duration (usually less than 100 hours) – *maximum power output rating*.
- **Prime** – continuous operation for an unlimited time (except for normal maintenance shutdowns), but with regular variations in load – *80 to 85 percent of the standby rating*.
- **Baseload** – continuous full-load operation for an unlimited time (except for normal maintenance shutdowns) – *70 to 75 percent of the standby rating*.

2.4.4 Performance and Efficiency Enhancements

2.4.4.1 Brake Mean Effective Pressure (BMEP) and Engine Speed

Engine power is related to engine speed and the BMEP during the power stroke. BMEP, as described above, can be regarded as an “average” cylinder pressure on the piston during the power stroke, and is a measure of the effectiveness of engine power output or mechanical efficiency. Engine manufacturers often include BMEP values in their product specifications. Typical BMEP values are as high as 320 psig for large natural gas engines and 350 psig for diesel engines. Corresponding peak combustion pressures

²² Stoichiometric or rich burn combustion is required for the use of 3-way catalytic converters for emissions control.

²³ Micropilot, prechamber dual fuel engines

are about 2,400 psig and 2,600 psig respectively. High BMEP levels increase power output, improve efficiency, and result in lower capital costs (\$/kW).

BMEP can be increased by raising combustion cylinder air pressure through increased turbocharging, improved aftercooling, and reduced pressure losses through improved air passage design. These factors all increase air charge density and raise peak combustion pressures, translating into higher BMEP levels. However, higher BMEP increases thermal and pneumatic stresses within the engine, and proper design and testing is required to ensure continued engine durability and reliability.

2.4.4.2 Turbocharging

Essentially all modern engines above 300 kW are turbocharged to achieve higher power densities. A turbocharger is basically a turbine-driven intake air compressor. The hot, high velocity exhaust gases leaving the engine cylinders power the turbine. Very large engines typically are equipped with two turbochargers. On a carbureted engine, turbocharging forces more air and fuel into the cylinders, which increases the engine output. On a fuel injected engine, the mass of fuel injected must be increased in proportion to the increased air input. Cylinder pressure and temperature normally increase as a result of turbocharging, increasing the tendency for detonation for both spark ignition and dual fuel engines and requiring a careful balance between compression ratio and turbocharger boost level. Turbochargers normally boost inlet air pressure on a 3:1 to 4:1 ratio. A wide range of turbocharger designs and models are used. Heat exchangers (called aftercoolers or intercoolers) are normally used on the discharge air from the turbocharger to keep the temperature of the air to the engine under a specified limit. Intercooling on forced induction engines improves volumetric efficiency by increasing the density of intake air to the engine (i.e. cold air charge from intercooling provides denser air for combustion thus allowing more fuel and air to be combusted per engine stroke increasing the output of the engine).

2.4.5 Capital Costs

This section provides typical study estimates for the installed cost of natural gas spark-ignited, reciprocating engine-driven generators in CHP applications. Capital costs (equipment and installation) are estimated for the five typical engine genset systems ranging from 100 kW to 9 MW. These are “typical” budgetary price levels; it should also be noted that installed costs can vary significantly depending on the scope of the plant equipment, geographical area, competitive market conditions, special site requirements, emissions control requirements, prevailing labor rates, and whether the system is a new or retrofit application.

The basic generator package consists of the engine connected directly to a generator without a gearbox. In countries where 60 Hz power is required, the genset operates at multiples of 60 – typically 1800 rpm for smaller engines, and 900 or 720 or 514 rpm for the large engines. In areas where 50 Hz power is used such as Europe and Japan, the engines run at speeds that are multiples of 50 – typically 1500 rpm for the small engines. In **Table 2-4**, System 4 is based on a German design, and operates at 1,500 rpm and produces 60 Hz power through a gearbox. The smaller engines are skid mounted with a basic control system, fuel system, radiator, fan, and starting system. Some smaller packages come with an enclosure, integrated heat recovery system, and basic electric paralleling equipment. The cost of the basic engine genset package plus the costs for added systems needed for the particular application comprise the total equipment cost. The total plant cost consists of total equipment cost plus installation labor and

materials (including site work), engineering, project management (including licensing, insurance, commissioning and startup), and financial carrying costs during the 4 to 18 month construction period. All engines are in low NO_x configuration. System 1, a stoichiometric (rich burn) engine, uses a three-way catalyst to reduce emissions to their final level. The other systems are all lean burn engines and are shown with a SCR, CO catalyst, and continuous emissions monitoring system (CEMS) that are required in environmentally sensitive areas such as Southern California and the Northeastern U.S.

Table 2-4 provides cost estimates for combined heat and power applications based on a single unit engine. The CHP system is assumed to produce hot water, although the multi-megawatt size engines are capable of producing low-pressure steam. The heat recovery equipment consists of the exhaust economizer that extracts heat from the exhaust system, process heat exchanger for extracting heat from the engine jacket coolant, circulation pump, control system, and piping. These cost estimates include interconnection and paralleling. The package costs are intended to reflect a generic representation of popular engines in each size category. The interconnection/electrical costs reflect the costs of paralleling a synchronous generator for the larger systems. The 100 kW system uses an inverter based generator that has been pre-certified for interconnection in most areas. Labor/materials represent the labor cost for the civil, mechanical, and electrical work as well as materials such as ductwork, piping, and wiring. Project and construction management also includes general contractor markup and bonding, and performance guarantees. Contingency is assumed to be 5 percent of the total equipment cost in all cases. Cost estimates for multiple unit installations have lower unit costs than single unit installations.

Table 2-4. Estimated Capital Cost for Typical Gas Engine Generators in Grid Interconnected CHP Applications

Capital Cost, \$/kW	System				
	1	2	3	4	5
Nominal Capacity (kW)	100	633	1121	3326	9341
Equipment (Costs in 2013 (\$/kW))					
Gen Set Package	\$1,400	\$400	\$375	\$350	\$575
Heat Recovery	\$250	\$500	\$500	\$500	\$175
Interconnect/Electrical	\$250	\$140	\$100	\$60	\$25
Exhaust Gas Treatment		\$750	\$500	\$230	\$150
Total Equipment	\$1,900	\$1,790	\$1,475	\$1,140	\$925
Labor/Materials	\$500	\$448	\$369	\$285	\$231
Total Process Capital	\$2,400	\$2,238	\$1,844	\$1,425	\$1,156
Project and Construction Management	\$125	\$269	\$221	\$171	\$139
Engineering and Fees	\$250	\$200	\$175	\$70	\$30
Project Contingency	\$95	\$90	\$74	\$57	\$46
Project Financing	\$30	\$42	\$52	\$78	\$62
Total Plant Cost (\$/kW)	\$2,900	\$2,837	\$2,366	\$1,801	\$1,433

Source: Compiled by ICF from vendor-supplied data

2.4.6 Maintenance

Maintenance costs vary with type, speed, size and number of cylinders of an engine. These costs typically include:

- Maintenance labor
- Engine parts and materials such as oil filters, air filters, spark plugs, gaskets, valves, piston rings, electronic components, etc. and consumables such as oil
- Minor and major overhauls.

Maintenance can either be done by in-house personnel or contracted out to manufacturers, distributors, or dealers under service contracts. Full maintenance contracts (covering all recommended service) generally cost between 1 to 2.5 cents/kWh depending on engine size, speed and service. Many service contracts now include remote monitoring of engine performance and conditions in addition to allowing for predictive maintenance. Service contract rates typically are all-inclusive, including the travel time of technicians on service calls.

Recommended service is comprised of routine short interval inspections/adjustments and periodic replacement of engine oil and filters, coolant, and spark plugs (typically 500 to 2,000 hours). An oil analysis is part of most preventative maintenance programs to monitor engine wear. A top-end overhaul is generally recommended between 8,000 and 30,000 hours of operation (see **Table 2-5**) that entails a cylinder head and turbocharger rebuild. A major overhaul is performed after 30,000 to 72,000 hours of operation and involves piston/liner replacement, crankshaft inspection, bearings, and seals.

Maintenance intervals are shown in **Table 2-5**.

Table 2-5. Representative Overhaul Intervals for Natural Gas Engines in Baseload Service

	Time Between Overhaul (thousand operating hours) as a Function of Engine Speed (rpm)				
	720 rpm	900 rpm	1200 rpm	1500 rpm	1800 rpm
Minor Overhaul	> 30	15 - 36	24 - 36	10 - 20	8 - 15
Major Overhaul	> 60	40 - 72	48 - 60	30 - 50	30 - 36

Source: SFA Pacific, Inc.

Maintenance costs presented in **Table 2-6** are based on engine manufacturer estimates for service contracts consisting of routine inspections and scheduled overhauls of the engine generator set. Costs are based on 8,000 annual operating hours expressed in terms of annual electricity generation. Engine maintenance can be broken into fixed components that need to be performed on a recurring basis regardless of the engine run time and variable components that depend on the hours of operation. The vendors quoted all O&M costs on a variable basis for a system in baseload operation.

Table 2-6. Typical Natural Gas Engine Maintenance Costs (\$2013/kWh)

	System				
	1	2	3	4	5
Nominal Capacity (kW)	100	633	1121	3326	9341
Service Contract	\$0.023 - \$0.025	\$0.020	\$0.018	\$0.015	\$0.0075
Consumables	included	\$0.001	\$0.001	\$0.001	.001
Total O&M Costs, 2013 \$/kWh	\$0.023 - \$0.025	\$0.021	\$0.019	\$0.016	.0085

Source: Compiled by ICF from vendor supplied data

2.4.7 Fuels

In addition to operation on natural gas, spark ignition engines operate on a variety of alternative gaseous fuels including:

- **Liquefied petroleum gas (LPG)** – propane and butane mixtures
- **Sour gas** – unprocessed natural gas as it comes directly from the gas well
- **Biogas** – any of the combustible gases produced from biological degradation of organic wastes, such as landfill gas, sewage digester gas, and animal waste digester gas
- **Industrial waste gases** – flare gases and process off-gases from refineries, chemical plants and steel mill
- **Manufactured gases** – typically low- and medium-Btu gas produced as products of gasification or pyrolysis processes

Factors that impact the operation of a spark ignition engine with alternative gaseous fuels include:

- **Volumetric heating value** – Since engine fuel is delivered on a volume basis, fuel volume into the engine increases as heating value decreases, requiring engine derating on fuels with lower Btu content. Derating is more pronounced with naturally aspirated engines, and depending on air requirements, turbocharging partially or totally compensates.
- **Autoignition characteristics and detonation tendency for fuels with lower octane rating such as propane** – This is often characterized by a calculated value known as the Methane Number (MN). Different manufacturers may calculate Methane Number differently. Gases with heavier hydrocarbon components (Propane, Ethane, Butane, etc.) have a lower Methane Number as they will tend to autoignite more easily.
- Contaminants that may impact engine component life or engine maintenance, or result in air pollutant emissions that require additional control measures.
- Hydrogen-containing fuels may require special measures (generally if hydrogen content by volume is greater than 5 percent) because of hydrogen’s unique flammability and explosion characteristics.

Table 2-7 presents representative constituents of some of the alternative gaseous fuels compared to natural gas. Industrial waste and manufactured gases are not included in the table because their compositions vary widely depending on their source. They typically contain significant levels of H₂ and/or CO. Other common constituents are CO₂, water vapor, one or more light hydrocarbons, and H₂S or SO₂.

Table 2-7. Major Constituents and LHV of Gaseous Fuels

Fuel Component / LHV	Natural Gas	LPG	Digester Gas	Landfill Gas
Methane, CH ₄ , % vol.	80 – 97	0	35 – 65	40 – 60
Ethane, C ₂ H ₆ , % vol.	3 – 15	0 – 2	0	0
Propane, C ₃ H ₈ , % vol.	0 – 3	75 - 97	0	0
Butane, C ₄ H ₁₀ , % vol.	0 – 0.9	0 - 2	0	0
Higher C _x H _{2x+2} , % vol.	0 – 0.2	0 - 20 ²⁴	0	0
CO ₂ , % vol.	0 – 1.8	0	30 – 40	40 - 60
N ₂ , % vol.	0 – 14	0	1 - 2	0 - 13
H ₂ , % vol.	0 – 0.1	0	0	0
LHV, (Btu/scf)	830 - 1075	2500	300 - 600	350 - 550

Source: SFA Pacific, Inc.; North American Combustion Handbook

Contaminants are a concern with many waste fuels, specifically acid gas components (H₂S, halogen acids, HCN; ammonia; salts and metal-containing compounds; organic halogen-, sulfur-, nitrogen-, and silicon-containing compounds such as siloxanes); and oils. In combustion, halogen and sulfur compounds form halogen acids, SO₂, some SO₃ and possibly H₂SO₄ emissions. The acids can also corrode downstream equipment. A substantial fraction of any fuel nitrogen oxidizes into NO_x in combustion. To prevent corrosion and erosion of components, solid particulates must be kept to very low concentrations. Various fuel scrubbing, droplet separation and filtration steps will be required if any fuel contaminant levels exceed manufacturers specifications. Landfill gas in particular often contains chlorine compounds, sulfur compounds, organic acids, and silicon compounds, which dictate pretreatment.

Once treated and acceptable for use in the engine, emissions performance profiles on alternative fuels are similar to natural gas engine performance. Specifically, the low emissions ratings of lean burn engines can usually be maintained on alternative fuels.

2.4.7.1 Liquefied Petroleum Gas

Liquefied petroleum gas (LPG) is composed primarily of propane and/or butane. While propane and butane ratings are higher than gasoline, most stationary spark ignition engines are designed with higher compression ratios that optimize operation with natural gas and its associated high methane number. Use of fuels with lower methane numbers like LPG in natural gas engines requires retarding of ignition timing and other appropriate adjustments to avoid detonation (*knocking*). LPG often serves as a back-up fuel where there is a possibility of interruption in the natural gas supply. Off-spec LPG may require cooling to condense out larger volumes of butane or heavier hydrocarbons that would aggravate engine knock. High butane content LPG is recommended only for low compression, naturally aspirated engines.

2.4.7.2 Field Gas

Field gas often contains more than 5 percent by volume of heavy ends (butane and heavier), as well as water, salts and H₂S and usually requires some scrubbing before use in natural gas engines. Cooling may be required to reduce the concentrations of butane and heavier components. Field gas usually contains

²⁴ High levels of heavier hydrocarbons are found in LPG derived from refinery processing

some propane and normally is used in low compression engines (both naturally aspirated and turbocharged). Retarded ignition timing eliminates detonation.

2.4.7.3 Biogas

Biogases (landfill gas and digester gas) are predominantly mixtures of methane and CO₂ with HHV in the range of 300 to 700 Btu/scf. Landfill gas also contains a variety of contaminants as discussed earlier. Biogases are produced essentially at or somewhat below atmospheric pressure so must be compressed for delivery to the engine. After compression, cooling and scrubbing or filtration are required to remove compressor oil, condensate, and any particulates that may have been entrained in the original gas. Scrubbing with a caustic solution may be required if acid gases are present. Because of the additional requirements for raw gas treatment, biogas powered engine facilities are more costly to build and operate than natural gas-based systems.

A key contaminant in biogas is a class of compounds called siloxanes, a subgroup of silicones containing Si-O bonds with organic radicals. These compounds are widely used for a variety of industrial processes and are also commonly added to consumer products, including detergents, shampoos, cosmetics, paper coatings, and textiles. Siloxanes in wastewater do not break down in wastewater treatment facilities or in landfills. As sludge undergoes anaerobic digestion, it may be subjected to temperatures of up to 150 °F. At these temperatures, siloxanes volatilize and enter the gas stream. Subjected to the heat of combustion in a reciprocating engine (turbine or microturbine), siloxanes leave behind hard deposits of silica on pistons and valve assemblies causing abrasion and impact damage that reduce the life and efficiency of the engine. Siloxanes need to be removed using refrigeration or sorbents such as activated carbon, alumina, synthetic resins, or liquid sorbents.²⁵

For engines operating on biogas, additional capital investment is required for this fuel clean-up, compression, and sometimes derating of the engine capacity due to the lower thermal energy content of the fuel. For a 1,000 kW reciprocating engine, the added equipment and installation cost is about \$600/kW.²⁶ Smaller systems can require nearly the same amount of equipment, so unit costs go up rapidly on smaller installations.

Improved engine design and hardened valve seats reduce siloxane damage on engines, thereby reducing the need for complete removal.

2.4.7.4 Industrial Waste Gases

Industrial waste gases that are common used as reciprocating engine fuels include refinery gases and process off-gases. Refinery gases typically contain components such as H₂, CO, light hydrocarbons, H₂S, and ammonia, as well as CO₂ and N₂. Process off-gases include a wide variety of compositions. Generally, waste gases are medium- to low-Btu content. Medium-Btu gases generally do not require significant engine derating; low-Btu gases usually require derating.

²⁵ Dick McCarrick, "Siloxanes and Biogas," Environmental Leader (online edition), July 10, 2012.
<http://www.environmentalleader.com/2012/07/10/siloxanes-and-biogas/>

²⁶ *Opportunities for and Benefits of Combined Heat and Power at Wastewater Treatment Facilities*, Eastern Research Group and EEA, Inc. (now ICF) for the U.S. EPA, 2007.

Depending on their origin and contaminants, industrial gases sometimes require pretreatment comparable to that applied to raw landfill gas. Particulates (e.g., catalyst dust), oils, condensable gases, water, C₄+ hydrocarbons and acid gases may all need to be removed. Process offgases are usually available at pressures of several atmospheres or higher, which are generally satisfactory for delivery to an on-site or nearby reciprocating engine facility.

2.4.8 System Availability

The percentage of time that a system is either up and running or available for use is referred to as its availability. Systems are unavailable during periods of scheduled maintenance or forced outages. Reciprocating engines are maintenance intensive but, they can provide high levels of availability, even in high load factor applications. While natural gas engine availabilities vary with engine type, speed and fuel quality, **Table 2-8** illustrates typical availability numbers based on a survey of natural gas engine gensets in CHP applications.

Table 2-8. Availabilities and Outage Rates for Natural Gas Engines

Reciprocating Engines	< 100 kW	100-800 kW	800-9000 kW
Systems Surveyed	14	8	18
Availability, %	97.93%	95.99%	98.22%
Forced Outage Rate, %	1.76%	1.98%	0.85%
Scheduled Outage Rate, %	0.73%	2.47%	1.12%

Source: ICF²⁷

Some engine manufacturers offer engine exchange programs or other maintenance options that increase the ability to promptly deliver and install replacement units on short notice, typically increasing facility availabilities to greater than 95 percent. The use of multiple units or back-up units at a site can further increase the availability of the overall facility over 99 percent.

2.5 Emissions and Emissions Control Options

Emissions of criteria pollutants – oxides of nitrogen (NO_x), carbon monoxide (CO), and volatile organic compounds (VOCs – unburned, non-methane hydrocarbons) – are the primary environmental concern with reciprocating engines operating on natural gas. Emissions of sulfur compounds (SO_x) depend only on the sulfur content of the fuel. SO_x emissions are an issue only in large, slow speed diesels firing heavy oils. SO_x emissions from natural gas engines are assumed to be less than 0.0006 lb/MMBtu.²⁸ Particulate matter (PM) can be an important pollutant for engines using liquid fuels. Ash and metallic additives in the fuel contribute to PM in the exhaust. Particulate emissions from 4-stroke lean burn natural gas engines are 4,000 times lower than for an uncontrolled diesel engine.

²⁷ Distributed Generation Operational Reliability and Availability Database, EEA, Inc. (now part of ICF), January 2004

²⁸ EPA AP-42, Natural Gas Fired Reciprocating Engines.

2.5.1 Emissions Characteristics

2.5.1.1 Nitrogen Oxides (NO_x)

NO_x emissions are usually the primary concern with natural gas engines and are a mixture of (mostly) NO and NO₂ in variable composition. In measurement, NO_x is reported as parts per million by volume in which both species count equally (e.g., ppmv at 15 percent O₂, dry). Other common units for reporting NO_x in reciprocating engines are g/hp-hr and g/kWh, or as an output rate such as lb/hr. Among natural gas engine options, lean burn natural gas engines produce the lowest NO_x emissions directly from the engine. However, rich burn engines can more effectively make use of three way catalysts (TWC) to produce very low emissions. If lean burn engines must meet extremely low emissions levels, as in California CARB 2007 standards of .07 lb/MWh then selective catalytic reduction must be added. Rich burn engines would qualify for this standard by taking a CHP credit for avoided boiler emissions. Lean burn engines can meet the standard using selective catalytic reduction (SCR). Both rich burn and lean burn engines have been certified for operation in Southern California meeting the stringent California Air Resources Board (CARB) 2007 standards.

The control of peak flame temperature through lean burn conditions has been the primary combustion approach to limiting NO_x formation in gas engines. Diesel engines produce higher combustion temperatures and more NO_x than lean burn gas engines, even though the overall diesel engine air/fuel ratio may be very lean. There are three reasons for this: (1) heterogeneous near-stoichiometric combustion; (2) the higher adiabatic flame temperature of distillate fuel; and (3) fuel-bound nitrogen.²⁹ The diesel fuel is atomized as it is injected and dispersed in the combustion chamber. Combustion largely occurs at near-stoichiometric conditions at the air-droplet and air-fuel vapor interfaces, resulting in maximum temperatures and higher NO_x. In contrast, lean-premixed homogeneous combustion used in lean burn gas engines results in lower combustion temperatures and lower NO_x production.

For any engine there are generally trade-offs between low NO_x emissions and high efficiency. There are also trade-offs between low NO_x emissions and emissions of the products of incomplete combustion (CO and unburned hydrocarbons). There are three main approaches to these trade-offs that come into play depending on regulations and economics. One approach is to control for lowest NO_x accepting a fuel efficiency penalty and possibly higher CO and hydrocarbon emissions. A second option is finding an optimal balance between emissions and efficiency. A third option is to design for highest efficiency and use post-combustion exhaust treatment.

2.5.1.2 Carbon Monoxide (CO)

CO and VOCs both result from incomplete combustion. CO emissions result when there is inadequate oxygen or insufficient residence time at high temperature. Cooling at the combustion chamber walls and reaction quenching in the exhaust process also contribute to incomplete combustion and increased CO emissions. Excessively lean conditions can lead to incomplete and unstable combustion and high CO levels. Therefore, control of NO_x through lean combustion can increase CO and VOC emissions out of the engine.

²⁹ Kirby Chapman, *Cost Effective Reciprocating Engine Emissions Control and Monitoring for E&P Field and Gathering Engines*, Kansas State University, 2003.

2.5.1.3 Unburned Hydrocarbons

Volatile hydrocarbons also called volatile organic compounds (VOCs) can encompass a wide range of compounds, some of which are hazardous air pollutants. These compounds are discharged into the atmosphere when some portion of the fuel remains unburned or just partially burned. Some organics are carried over as unreacted trace constituents of the fuel, while others may be pyrolysis products of the heavier hydrocarbons in the gas. Volatile hydrocarbon emissions from reciprocating engines are normally reported as non-methane hydrocarbons (NMHCs).

2.5.1.4 Carbon Dioxide (CO₂)

While not considered a pollutant in the ordinary sense of directly affecting health, emissions of carbon dioxide (CO₂) are of concern due to its contribution to climate change. The amount of CO₂ emitted is a function of both fuel carbon content and system efficiency. The fuel carbon content of natural gas is 34 lbs carbon/MMBtu; oil is 48 lbs carbon/MMBtu; and (ash-free) coal is 66 lbs carbon/MMBtu. As converted to CO₂ in the exhaust, these values are 117 lb/MMBtu for natural gas, 160 lb/MMBtu for diesel oil, and 205-226 lb/MMBtu for coal.

2.5.2 Emissions Control Options

Emissions from natural gas SI engines have improved significantly in the last decade through better design and control of the combustion process and through the use of exhaust catalysts. Advanced lean burn natural gas engines are available that produce NO_x levels as low 1.8 lb/MWh and CO emissions of 8.1lb/MWh before any exhaust gas treatment. Adding selective catalytic reduction (SCR) and a CO oxidation catalyst can allow lean burn reciprocating engines to meet the very stringent California South Coast emissions standards of 0.07 lb/MWh for NO_x and 1.0 lb/MWh for CO.

NO_x control has been the primary focus of emission control research and development in natural gas engines. The following provides a description of the most prominent emission control approaches.

2.5.2.1 Combustion Process Emissions Control

Control of combustion temperature has been the principal focus of combustion process control in gas engines. Combustion control requires tradeoffs – high temperatures favor complete burn up of the fuel and low residual hydrocarbons and CO, but promote NO_x formation. Lean combustion dilutes the combustion process and reduces combustion temperatures and NO_x formation, and allows a higher compression ratio or peak firing pressures resulting in higher efficiency. However, if the mixture is too lean, misfiring and incomplete combustion occur, increasing CO and VOC emissions.

Lean burn engine technology was developed during the 1980s as a direct response to the need for cleaner burning gas engines. As discussed earlier, thermal NO_x formation is a function of both flame temperature and residence time. The focus of lean burn developments was to lower combustion temperature in the cylinder using lean fuel/air mixtures. Lean combustion decreases the fuel/air ratio in the zones where NO_x is produced so that peak flame temperature is less than the stoichiometric adiabatic flame temperature, therefore suppressing thermal NO_x formation. Most lean burn engines use turbocharging to supply excess air to the engine and produce the homogeneous lean fuel-air mixtures. Lean burn engines generally use 50 to 100 percent excess air (above stoichiometric). The typical uncontrolled emissions rate for lean burn natural gas engines is between 1.5-6.0 lb/MWh.

As discussed above, an added performance advantage of lean burn operation is higher output and higher efficiency. Optimized lean burn operation requires sophisticated engine controls to ensure that combustion remains stable and NO_x reduction is maximized while minimizing emissions of CO and VOCs. **Table 2-9** shows data for a large lean burn natural gas engine that illustrates the tradeoffs between NO_x emissions control and efficiency. At the lowest achievable NO_x levels (45 to 50 ppmv), almost 1.5 percentage points are lost on full rated efficiency.

Table 2-9. Uncontrolled NO_x Emissions versus Efficiency Tradeoffs

Engine Characteristics	Low NO _x	High Efficiency
Capacity (MW)	9.3	9.3
Speed (rpm)	720	720
Efficiency, LHV (percent)	44.1	45.7
Emissions:		
NO _x (g/kWh) (ppmv @ 15% O ₂)	0.62 45	1.2 90
CO (g/kWh) (ppmv @ 15 % O ₂)	1.9 226	1.3 158
NMHC (g/kWh) (ppmv @ 15% O ₂)	1.0 209	0.71 153

Data Source: Based on engine manufacturer's data – Wartsila 20V34SG Prechamber Lean Burn Gas Engine³⁰

Combustion temperature can also be controlled to some extent in reciprocating engines by one or more of the following techniques:

- Delaying combustion by retarding ignition or fuel injection.
- Diluting the fuel-air mixture with exhaust gas recirculation (EGR), which replaces some of the air and contains water vapor that has a relatively high heat capacity and absorbs some of the heat of combustion.
- Introducing liquid water by direct injection or via fuel oil emulsification – evaporation of the water cools the fuel-air mixture charge.
- Reducing the inlet air temperature with a heat exchanger after the turbocharger or via inlet air humidification.
- Modifying valve timing, compression ratio, turbocharging, and the combustion chamber configuration.

Water injection and EGR reduce diesel NO_x emissions 30 to 60 percent from uncontrolled levels. The incorporation of water injection and other techniques to lean burn gas engines is the focus of ongoing R&D efforts for several engine manufacturers and is being pursued as part of the Department of

³⁰ Wartsila Gas-fired Engines. http://www.wartsila.com/en/power-plants/technology/combustion-engines/gas-engines#expandable_id

Energy’s Advanced Reciprocating Engine Systems (ARES) program. One of the goals of the program is to develop a 45 percent efficient (HHV) medium sized natural gas engine operating at 0.3 lb NO_x/MWh (0.1 g NO_x/bhph).

2.5.2.2 Post-Combustion Emissions Control

There are several types of catalytic exhaust gas treatment processes that are applicable to various types of reciprocating engines. **Table 2-10** shows the methods in use today, the applicable engine types, and the pollutant reduction achievable.

Table 2-10. Post-Combustion Exhaust Gas Cleanup Options

Emission Control Technology	Applicable Engine Type	Typical Performance Reductions, %			
		CO	NMHC	NO _x	PM
Diesel Oxidation Catalyst (DOC)	Diesel	90	80	0	20
Catalyzed Diesel Particulate Filter (DPF)	Diesel	90	90	0	90+
Non-selective Catalytic Reduction (NSCR)	Rich Burn Natural Gas	90	80	95	0
NG Oxidation Catalyst	Lean Burn Natural Gas	95	95	0	0
Selective Catalytic Reduction (SCR)	Lean Burn Diesel or Natural Gas	0	0	95	0

Reference: Jay Warner and Gary Bremigan, *System Solutions for Optimizing Exhaust Emission Control Systems*, Universal Acoustic & Emissions Control Technologies USA, 2010

2.5.2.3 Oxidation Catalysts

Oxidation catalysts generally are precious metal compounds that promote oxidation of CO and hydrocarbons to CO₂ and H₂O in the presence of excess O₂. CO and non-methane hydrocarbon analyzer (NMHC) conversion levels of 95 percent are achievable. Methane conversion may approach 60 to 70 percent. Oxidation catalysts are now widely used with all types of engines, including diesel engines. They are being used increasingly with lean burn gas engines to reduce their relatively high CO and hydrocarbon emissions.

2.5.2.4 Diesel Particulate Filter

While not an issue for spark ignition engines firing gaseous fuels, compression ignition engines fueled by diesel or heavy oil produce particulates that must be controlled. Diesel particulate filters can reduce over 90 percent of particulate (soot) emissions from diesel engines. There are a variety of filter materials and regeneration strategies used. Currently, there are no commercially available particulate control devices available for large, medium speed diesel engines.³¹

2.5.2.5 Three-Way Catalyst (Non Specific Catalytic Reduction)

The catalytic three-way conversion process (TWC) is the basic automotive catalytic converter process that reduces concentrations of all three major criteria pollutants – NO_x, CO, and VOCs. The TWC is also

³¹ Private Communication, Wartsila, January 2014.

called non-selective catalytic reduction (NSCR). NO_x and CO reductions are generally greater than 90 percent, and VOCs are reduced approximately 80 percent in a properly controlled TWC system. Because the conversions of NO_x to N₂, the conversion of CO and hydrocarbons to CO₂ and H₂O will not take place in an atmosphere with excess oxygen (exhaust gas must contain less than 0.5 percent O₂), TWCs are only effective with stoichiometric or rich-burning engines. Typical “engine out” NO_x emission rates for a rich burn engine are 10 to 15 gm/bhp-hr. NO_x emissions with TWC control are as low as 0.15 g/bhp-hr.

Stoichiometric and rich burn engines have significantly lower efficiency than lean burn engines (higher carbon emissions) and only certain sizes (<1.5 MW) and high speeds are available. The TWC system also increases maintenance costs by as much as 25 percent. TWCs are based on noble metal catalysts that are vulnerable to poisoning and masking, limiting their use to engines operated with clean fuels (e.g., natural gas and unleaded gasoline). In addition, the engines must use lubricants that do not generate catalyst poisoning compounds and have low concentrations of heavy and base metal additives. Unburned fuel, unburned lube oil, and particulate matter can also foul the catalyst. TWC technology is not applicable to lean burn gas engines or diesels.

2.5.2.6 Selective Catalytic Reduction (SCR)

This technology selectively reduces NO_x to N₂ in the presence of a reducing agent. NO_x reductions of 80 to 90 percent are achievable with SCR. Higher reductions are possible with the use of more catalyst or more reducing agent, or both. The two agents used commercially are ammonia (NH₃ in anhydrous liquid form or aqueous solution) and aqueous urea. Urea decomposes in the hot exhaust gas and SCR reactor, releasing ammonia. Approximately 0.9 to 1.0 mole of ammonia is required per mole of NO_x at the SCR reactor inlet in order to achieve an 80 to 90 percent NO_x reduction.

SCR systems are considered commercial today and represent the only technology that will reduce NO_x emissions to the levels required in Southern California and the Northeast U.S. Still, SCR adds significantly to the capital and operating cost of a reciprocating engine CHP system. As shown previously in **Table 2-4**, SCR with oxidation catalyst and associated continuous energy monitoring system adds between \$150-\$700/kW to the capital cost for a lean burn reciprocating engine CHP installation. The cost burden is higher for smaller engines.

2.5.3 Gas Engine Emissions Treatment Comparison

Table 2-11 shows achievable emissions for each of the five representative gas engine systems. The emissions presented assume available exhaust treatment. System 1, the 100 kW engine, is a high speed, rich burn engine. Use of a TWC system with EGR provides NO_x emissions of just under 0.07 lb NO_x per MWh after credit is taken for the thermal energy provided.³² The Lean burn engine systems use an SCR/CO system providing emissions reduction that meets the CARB 2007 emissions limits without consideration of the thermal energy credit.

With current commercial technology, highest efficiency and lowest NO_x are not achieved simultaneously. Therefore many manufacturers of lean burn gas engines offer different versions of an engine – a low NO_x version and a high efficiency version – based on different tuning of the engine

³² CARB 2007 emissions regulations allow CHP systems to include both the electric and thermal output in the calculation of output based emissions.

controls and ignition timing. With the addition of SCR after-treatment, described below, some manufacturers tune engines for higher efficiency and allow the SCR system to remove the additional NO_x. Achieving highest efficiency operation results in conditions that generally produce twice the NO_x as low NO_x versions (e.g., 3 lb/MWh versus 1.5 lb/MWh). Achieving the lowest NO_x typically entails sacrifice of 1 to 2 points in efficiency (e.g., 38 percent versus 36 percent). In addition, CO and VOC emissions are higher in engines optimized for minimum NO_x.

Table 2-11. Gas Engine Emissions Characteristics with Available Exhaust Control Options

Emissions	System				
	1	2	3	4	5
Nominal Capacity (kW)	100	633	1121	3326	9341
Electrical Efficiency (% HHV)	27.0%	34.5%	36.8%	40.4%	41.6
Engine Combustion	Rich	Rich	Lean	Lean	Lean
Precatalyst Emissions					
NO _x (lb/MWh)		1.77	1.77	1.77	2.64 ³³
CO (lb/MWh)		8.12	8.12	8.12	4.18
VOC (lb/MWh)		0.97	0.97	0.97	1.39
Post Catalyst Emissions					
NO _x (lb/MWh)	0.070	0.07	0.07	0.07	.07
CO (lb/MWh)	0.200	0.20	0.20	0.20	.20
VOC, (lb/MWh)	0.1	0.10	0.10	0.10	.10
CO ₂ Gross (lb/MWh)	1,479	1,158	1,084	989	988
CO ₂ Net (lb/MWh)	499	516	520	520	540

Source: Compiled by ICF from vendor supplied data

2.6 Future Developments

Reciprocating engines have improved significantly over the last two decades in terms of increased efficiency and reduced emissions. Electronic engine control and improved combustion chamber design, including the use of precombustion chambers, allow engines to operate on leaner fuel mixtures. Improvements in materials and design have allowed engines to operate at higher speeds and power densities while still maintaining long life.

These improvements have been the combined results of collaborative research efforts by private industry, universities, and the federal government. Public private partnerships such as the DOE Advanced Reciprocating Engine System (ARES) funded by DOE and the Advanced Reciprocating Internal Combustion Engine (ARICE) program funded by the California Energy Commission (CEC) have focused attention on the development of the next generation reciprocating engine.

³³ The Wartsila engine shown here (System 5) when matched with SCR is tuned for best efficiency at the expense of higher uncontrolled NO_x – letting the SCR remove the NO_x. This strategy results in lower overall operating costs.

The ARES program has been active for more than 10 years. The program has produced and commercialized Phase I and Phase II engines with current work on a Phase III engine to reach the overall design efficiency goals of 0.1 g/bhp NO_x emissions, 50 percent BTE efficiency, 80+ percent CHP efficiency, maintenance costs of \$0.01/kWh while maintaining cost competitiveness.³⁴

For a technology originally developed in the 19th century, reciprocating internal combustion engines have continually improved and adapted to the needs of the market more than 100 years later. Ongoing improvements in efficiency, cost, and emissions reduction will ensure that reciprocating engines will continue to remain viable and competitive with newer technologies such as fuel cells and microturbines in the distributed generation market. Installations of multiple large engines have proven to be competitive in power generation applications of more than 200 MW.

³⁴ *Industrial Distributed Energy R&D Portfolio Report: Summary*, U.S. Department of Energy Advanced Manufacturing Office, June 2011.

Section 3. Technology Characterization – Combustion Turbines

3.1 Introduction

Gas turbines have been in use for stationary electric power generation since the late 1930s. Turbines went on to revolutionize airplane propulsion in the 1940s, and since the 1990s through today, they have been a popular choice for new power generation plants in the United States.

Gas turbines are available in sizes ranging from 500 kilowatts (kW) to more than 300 megawatts (MW) for both power-only generation and combined heat and power (CHP) systems. The most efficient commercial technology for utility-scale power plants is the gas turbine-steam turbine combined-cycle plant that has efficiencies of more than 60 percent (measured at lower heating value [LHV]³⁵). Simple-cycle gas turbines used in power plants are available with efficiencies of over 40 percent (LHV). Gas turbines have long been used by utilities for peaking capacity. However, with changes in the power industry and advancements in the technology, the gas turbine is now being increasingly used for base-load power.

Gas turbines produce exhaust heat at high temperatures that can be recovered in a CHP configuration to produce steam for process use. Such CHP configurations can reach overall system efficiencies (electricity and useful thermal energy) of 70 to 80 percent. By the early 1980s, the efficiency and reliability of smaller gas turbines (1 to 40 MW) had progressed sufficiently to be an attractive choice for industrial and large institutional users for CHP applications.

Gas turbines have very low emissions compared to other fossil-powered generation technologies. With catalytic exhaust cleanup or lean pre-mixed combustion, some large gas turbines achieve emissions of oxides of nitrogen (NO_x) well below 10 parts per million (ppm).³⁶ Because of their relatively high efficiency and the reliance on natural gas as a primary fuel, gas turbines emit substantially less carbon dioxide (CO₂) per kilowatt-hour (kWh) generated than other fossil technology in commercial use.³⁷

3.2 Applications

Gas turbines are used in a variety of stationary applications:

- **Electric utility central station power generation** – Gas turbines are used widely by the electric utility industry. Combined cycle turbine plants contribute to base-load power needs, and simple cycle turbines are used for meeting peak-load. Today, gas turbines comprise 32 percent, or 315 gigawatts (GW), of central station power plant capacity

³⁵ Most of the efficiencies quoted in this report are based on higher heating value (HHV), which includes the heat of condensation of the water vapor in the combustion products. In engineering and scientific literature concerning heat engine efficiencies the lower heating value (LHV – which does not include the heat of condensation of the water vapor in the combustion products) is usually used. The HHV is greater than the LHV by approximately 10 percent with natural gas as the fuel (e.g., 50 percent LHV is equivalent to 55 percent HHV). HHV efficiencies are about 8 percent greater for oil (liquid petroleum products) and 5 percent for coal.

³⁶ Volumetric emissions for gas turbines are measured at 15 percent oxygen in the exhaust.

³⁷ Fuel cells, which produce electricity from hydrogen and oxygen, emit only water vapor. There are emissions associated with producing the hydrogen supply depending on its source. However, most fuel cell technologies are still being developed, with only one type (phosphoric acid fuel cell) commercially available in limited production.

- **Combined heat and power** – Gas turbines are used extensively for CHP applications providing efficient, economic, and reliable service. Gas turbines comprise 63 percent, or 51.5 GW, of total installed CHP capacity in the U.S.³⁸ Close to 80 percent of this gas turbine CHP capacity is in large combined cycle plants that maximize the export of power to the electrical grid.³⁹ The remaining GT CHP capacity is made up of simple-cycle gas turbine based CHP systems, typically less than 40 MW.
- **Mechanical drive** – Oil and gas production, processing, transmission, and some process industries use gas turbines for pumping, compression, and other mechanical drive operations. In mechanical power applications, the turbine shaft power is used directly. There is no electrical generator, though there can be heat recovery, and such systems can be classified as CHP.
- **Distributed power-only** – Gas turbines are used for distributed power generation at remote oilfield facilities and can be used by industry and utilities alike for portable power generation. Large industrial facilities install simple-cycle gas turbines without heat recovery to provide peaking power in capacity constrained areas, and utilities often place gas turbines in the 5 to 40 MW size range at substations to provide incremental capacity and grid support. A number of turbine manufacturers and packagers offer mobile turbine generator units in the 5-40 MW size range that can be used in one location during a period of peak demand and then transported to another location for the following season.

Gas turbines are ideally suited for CHP applications because their high-temperature exhaust can be used to generate process steam at conditions as high as 1,200 pounds per square inch gauge (psig) and 900 °F or used directly in industrial processes for heating or drying. A typical industrial CHP application for gas turbines is a chemical plant with a 25 MW simple cycle gas turbine supplying base-load power to the plant with an unfired heat recovery steam generator (HRSG) on the exhaust. This gas turbine CHP system will produce approximately 29 MW thermal (MW_{th}) of steam for process use within the plant.

A typical commercial/institutional CHP application for gas turbines is a college or university campus with a 5 MW simple-cycle gas turbine. Approximately 8 MWth of 150 psig to 400 psig steam (or hot water) is produced in an unfired heat recovery steam generator and sent to a central thermal loop for campus space heating during the winter, or to single-effect absorption chillers to provide cooling during the summer.

3.3 Technology Description

3.3.1 Basic Process

Gas turbine systems operate on the Brayton thermodynamic cycle, a constant pressure open cycle heat engine. The Brayton cycle consists of a compressor, a combustion chamber, and an expansion turbine. The compressor heats and compresses the inlet air which is then further heated by the addition of fuel in the combustion chamber. The hot air and combustion gas mixture drives the expansion turbine producing enough energy to provide shaft-power to the generator or mechanical process and to drive the compressor as well. The power produced by an expansion turbine and consumed by a compressor is

³⁸ Electric utility sector gas turbine capacity is from EIA data (2014). CHP gas turbine total capacity based on the ICF CHP Installations database.

³⁹ ICF CHP Installations Database, 2014

proportional to the absolute temperature of the gas passing through the device. Consequently, it is advantageous to operate the expansion turbine at the highest practical temperature consistent with economic materials and internal blade cooling technology and to operate the compressor with inlet air flow at as low a temperature as possible. As technology advances permit higher turbine inlet temperature, the optimum pressure ratio also increases.

There are several variations of the Brayton cycle in use today. Fuel consumption may be decreased by preheating the compressed air with heat from the turbine exhaust using a recuperator or regenerator. The compressor work may also be reduced and net power increased by using intercooling or precooling techniques. In a combined cycle, the exhaust may be used to raise steam in a boiler and to generate additional power. **Figure 3-1** shows the configuration for an unrecuperated industrial gas turbine with shaft power, driving an electric generator and the exhaust heat powering a heat recovery steam generator (HRSG) with supplementary firing capability.

Figure 3-1. Gas Turbine Configuration with Heat Recovery

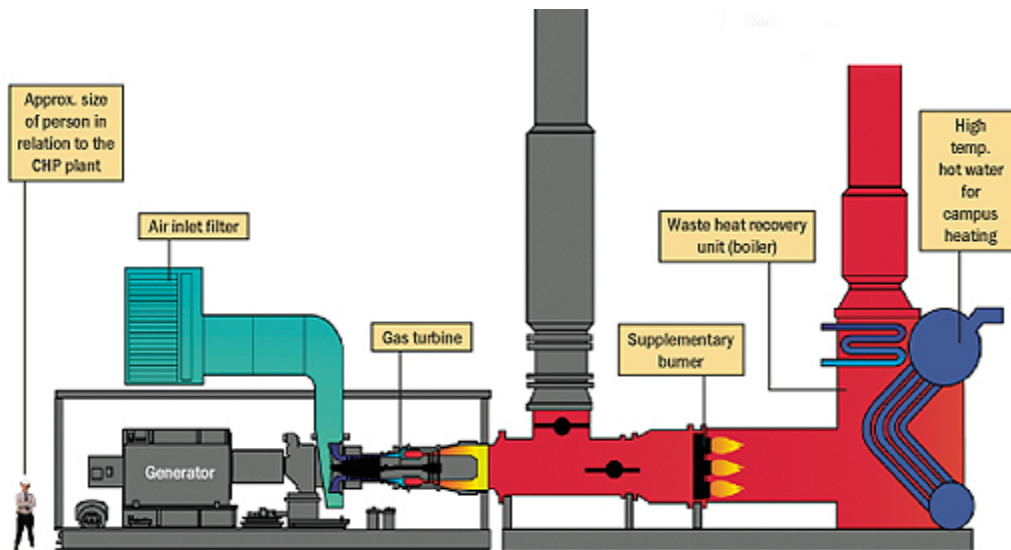

Source: University of Calgary

Gas turbine exhaust is quite hot, up to 800 to 900°F for smaller industrial turbines, and up to 1,100°F for some new, large central station utility machines and aeroderivative turbines. Such high exhaust temperatures permit direct use of the exhaust for applications such as combustion air preheating, drying, or other applications requiring hot air stream. Such direct use of the exhaust is also called *closely coupled* CHP. More commonly, the exhaust heat is recovered with the addition of a heat recovery steam generator, which produces steam or hot water. A portion or all of the steam generated by the HRSG may be used to generate additional electricity through a steam turbine in a combined cycle configuration.

A gas turbine system is considered to be a combined heat and power (CHP) configuration if the waste heat (i.e., thermal energy) generated by the turbine is applied in an end-use. For example, a simple-cycle gas turbine using the exhaust in a direct heating process is a CHP system. A gas turbine system that uses the turbine exhaust in a HRSG, and then uses the steam from the HRSG to produce electricity in a steam turbine is a combined cycle unit, and is not considered to be CHP (no end-use thermal need). This latter configuration is a waste heat-to-power (WHP) system.

Key gas turbine design characteristics are shown in **Table 3-1**.

Table 3-1. Gas Turbine Design Characteristics

Thermal output	Gas turbines produce a high quality (high temperature) thermal output suitable for most combined heat and power applications. High-pressure steam can be generated or the exhaust can be used directly for process drying and heating. The exhaust can also be used to produce chilled water using an absorption chiller.
Fuel flexibility	Gas turbines operate on natural gas, synthetic gas, landfill gas, and fuel oils. Plants typically operate on gaseous fuel with a stored liquid fuel for backup to obtain the less expensive, interruptible rate for natural gas.
Reliability and life	Modern gas turbines have proven to be reliable power generators given proper maintenance. Time to overhaul is typically 25,000 to 50,000 hours.
Size range	Gas turbines are available in sizes from 500 kW to over 300 MW.
Emissions	Many gas turbines burning gaseous fuels (mainly natural gas) feature lean premixed burners (also called dry low-NO _x combustors) that produce NO _x emissions below 25 ppm, with laboratory data showing emissions down to 9 ppm, and simultaneous low CO emissions in the 10 to 50 ppm range. ⁴⁰ Selective catalytic reduction (SCR) or catalytic combustion can further reduce NO _x emissions. Many gas turbines sited in locales with stringent emission regulations use SCR after-treatment to achieve single-digit (below 9 ppm) NO _x emissions.
Part-load operation	Because gas turbines reduce power output by reducing combustion temperature, efficiency at part load can be substantially below that of full-power efficiency.

3.3.2 Components

Figure 3-2 shows the primary components of a simple cycle gas turbine.

Figure 3-2. Components of Simple Cycle Gas Turbine

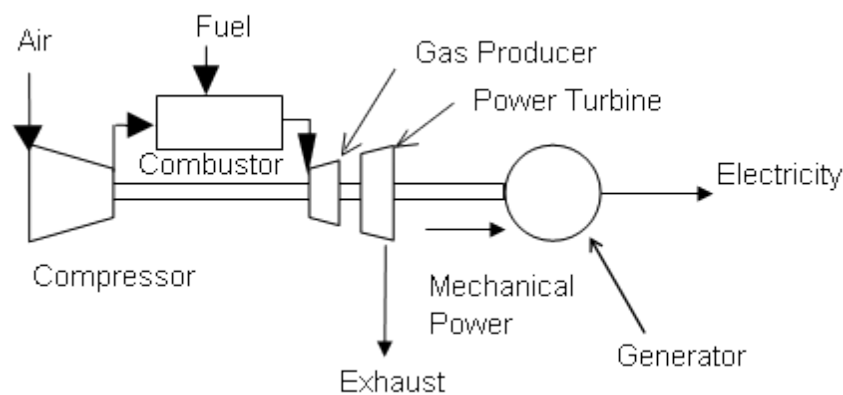

Higher temperature and pressure ratios result in higher efficiency and specific power, or power-to-weight ratio. Thus, the general trend in gas turbine advancement has been towards a combination of

⁴⁰ Gas turbines have high oxygen content in their exhaust because they burn fuel with high excess air to limit combustion temperatures to levels that the turbine blades, combustion chamber and transition section can handle without compromising system life. Consequently, emissions from gas turbines are evaluated at a reference condition of 15 percent oxygen. For comparison, boilers use 3 percent oxygen as the reference condition for emissions, because they can minimize excess air and thus waste less heat in their stack exhaust. Note that due to the different amount of diluent gases in the combustion products, the NO_x measurement of 9 ppm @ 15 percent oxygen is approximately equivalent to 27 ppm @ 3 percent oxygen.

higher temperatures and pressures. While such advancements increase the manufacturing cost of the machine, the higher value, in terms of greater power output and higher efficiency, provides net economic benefits.

3.3.2.1 Types of Gas Turbines

Aeroderivative Gas Turbines

Aeroderivative gas turbines for stationary power are adapted from their jet and turboshaft aircraft engine counterparts. While these turbines are lightweight and thermally efficient, they are usually more expensive than products designed and built exclusively for stationary applications. The largest aeroderivative generation turbines available are 40 to 50 MW in capacity. Many aeroderivative gas turbines for stationary use operate with compression ratios in the range of 30:1, requiring a high-pressure external fuel gas compressor. With advanced system developments, larger aeroderivative turbines (>40 MW) have achieved over 43 percent simple-cycle efficiency (LHV).

Industrial Gas Turbines

Industrial gas turbines, or frame gas turbines, are exclusively for stationary power generation and are available in capacities from 1 to over 300 MW. They are generally less expensive, more rugged, can operate longer between overhauls, and are more suited for continuous base-load operation with longer inspection and maintenance intervals than aeroderivative turbines. However, they are less efficient and much heavier. Industrial gas turbines generally have more modest compression ratios (up to 16:1) and often do not require an external fuel gas compressor. Larger industrial gas turbines (>100 MW) are approaching simple-cycle efficiencies of approximately 40 percent (LHV) and combined-cycle efficiencies of 60 percent (LHV).

Industrial plants use gas turbines between 500 kW to 40 MW for on-site power generation and for direct mechanical drive applications. Small gas turbines also drive compressors on long distance natural gas pipelines. In the petroleum industry, turbines drive gas compressors to maintain well pressures and provide compression and pumping for refineries and petrochemical plants. In the steel industry, turbines drive air compressors used for blast furnaces. In process industries such as chemicals, refining and paper, and in large commercial and institutional applications turbines are used in combined heat and power mode generating both electricity and steam for use on-site.

3.4 Performance Characteristics

The efficiency of the Brayton cycle is a function of pressure ratio, ambient air temperature, turbine inlet air temperature, the efficiency of the compressor and turbine elements, turbine blade cooling requirements, and also any other performance enhancements (i.e., recuperation, intercooling, inlet air cooling, reheat, steam injection, or combined cycle). All of these parameters, along with gas turbine internal mechanical design features, continue to improve with time. Therefore newer machines are usually more efficient than older ones of the same size and general type.

Table 3-2 summarizes performance characteristics for typical commercially available gas turbine CHP systems over the 3 to 45 MW size range. In the table, note that:

- Heat rates shown are from manufacturers’ specifications and are net of losses due to inlet and outlet pressure drop and parasitic power.
- Available thermal energy (steam output) was calculated from information provided by the vendors or published turbine data on turbine exhaust temperatures and flows.
- CHP steam estimates are based on an unfired HRSG producing dry, saturated steam at 150 psig.
- Total efficiency is defined as the sum of the net electricity generated plus steam produced for plant thermal needs divided by total fuel input to the system. Higher steam pressures can be obtained but at slightly lower total efficiencies. Additional steam can be generated and total efficiency further increased with duct firing in the HRSG (see heat recovery section).
- To estimate fuel savings effective electrical efficiency is a more useful value than overall efficiency. Effective electric efficiency is calculated assuming the useful thermal output from the CHP system would otherwise be generated by an 80 percent efficient boiler. The theoretical boiler fuel is subtracted from the total fuel input and the remaining fuel input used to calculate the effective electric efficiency which can then be compared to traditional electric generation.
- The ratings in the table are all for systems operating in baseload (continuous) duty. Peaking and emergency power units generally have lower efficiency, lower capital cost, higher emissions, and are limited in their run hours.

The data in the table show that electrical efficiency generally increases as combustion turbines become larger. As electrical efficiency increases, the absolute quantity of thermal energy available to produce steam decreases per unit of power output, and the ratio of power to heat for the CHP system increases. A changing ratio of power to heat impacts project economics and may affect the decisions that customers make in terms of CHP acceptance, sizing, and the desirability of selling power. It is generally recommended to size a CHP system based on a site’s thermal load demand; therefore, such power to heat ratios are important characteristics to consider.

Table 3-2. Typical Performance for Gas Turbines in CHP Operation

Cost & Performance Characteristics ⁴¹	System				
	1	2	3	4	5
Net Electricity Capacity (kW)	3,304	7,038	9,950	20,336	44,488
Installed Cost (2013 \$/kW) ⁴²	\$3,281	\$2,080	\$1,976	\$1,518	\$1,248
Electric Heat Rate (Btu/kWh), HHV ⁴³	14,247	11,807	12,482	10,265	9,488
Electrical Efficiency (%), HHV	23.95%	28.90%	27.34%	33.24%	35.96%
Fuel Input (MMBtu/hr), HHV	47.1	83.1	124.2	208.7	422.1
Required Fuel Gas Pressure (psig)	166.8	299.4	362.3	405.2	538

⁴¹ Data based on: 3 MW – Solar Turbines Centaur 40, 7 MW – Solar Taurus 70, 10 MW – Solar Mars 100, 20 MW – Solar Titan 250, 45 MW – GE LM6000.

⁴² Installed costs based on CHP system producing 150 psig saturated steam with an unfired heat recovery steam generator, gas compression, building, with SCR/CO/CEMS exhaust gas treatment in an uncomplicated installation at a customer site.

⁴³ All turbine and engine manufacturers quote heat rates in terms of the lower heating value (LHV) of the fuel. Electric utilities measure power plant heat rates in terms of HHV and fuel prices are given in terms of the HHV. The ratio of LHV to HHV is approximately 0.9 for natural gas.

Table 3-2. Typical Performance for Gas Turbines in CHP Operation

Cost & Performance Characteristics ⁴¹	System				
	1	2	3	4	5
CHP Characteristics					
Exhaust Flow (1,000 lb/hr)	149.2	211.6	334	536	1047
GT Exhaust Temperature (Fahrenheit)	838	916	913	874	861
HRSG Exhaust Temperature (Fahrenheit)	336	303	322	326	300
Steam Output (MMBtu/hr)	19.66	34.44	52.36	77.82	138.72
Steam Output (1,000 lbs/hr)	19.65	34.42	52.32	77.77	138.64
Steam Output (kW equivalent)	5,760	10,092	15,340	22,801	40,645
Total CHP Efficiency (%), HHV ⁴⁴	65.7%	70.4%	69.5%	70.5%	68.8%
Power/Heat Ratio ⁴⁵	0.57	0.70	0.65	0.89	1.09
Net Heat Rate (Btu/kWh) ⁴⁶	6,810	5,689	5,905	5,481	5,590
Effective Electrical Efficiency (%) ⁴⁷	50%	60%	58%	62%	61%
Thermal Output as Fraction of Fuel Input	0.42	0.41	0.42	0.37	0.33
Electric Output as Fraction of Fuel Input	0.24	0.29	0.27	0.33	0.36

Source: Compiled by ICF from vendor-supplied data

3.4.1 Fuel Supply Pressure

As shown previously in **Figure 3-2**, the fuel gas is mixed with the combustion air after it has been heated and compressed. Therefore, the fuel gas must also be compressed to a pressure somewhat higher than the combustion air. This pressure is determined by the turbine pressure ratio. The fuel gas compressor size and energy requirements are determined not only by the required outlet conditions but also by the delivery pressure. Depending on the supply pressure of the gas being delivered to the site, the cost and power consumption of the fuel gas compressor can be a significant consideration. **Table 3-3** shows the power required to compress natural gas from supply pressures typical of commercial and industrial service to the pressures required by typical industrial gas turbines. Required supply pressures generally increase with gas turbine size.

⁴⁴ Total Efficiency = (net electric generated + net steam produced for thermal needs)/total system fuel input

⁴⁵ Power/Steam Ratio = CHP electrical power output (Btu)/ useful steam output (Btu)

⁴⁶ Net Heat Rate = (total fuel input to the CHP system - the fuel that would be normally used to generate the same amount of thermal output as the CHP system output assuming an efficiency of 80 percent)/CHP electric output (kW).

⁴⁷ Effective Electrical Efficiency = (CHP electric power output) / (total fuel into CHP system – total heat recovered/0.8); Equivalent to 3,412 Btu/kWh/Net Heat Rate.

Table 3-3. Power Requirements for Natural Gas Fuel Compression⁴⁸

Turbine Conditions	System				
	1	2	3	4	5
Turbine Electric Capacity (kW)	3,304	7,038	9,950	20,336	44,488
Turbine Pressure Ratio	10.1	17.6	17.7	24	31.9
Pressure Required, psig	167	299	362	405	538
Required Compression Power (kW)					
55 psig gas supply pressure	51	162	289	538	1,370
150 psig gas supply pressure	21	63	113	211	510
250 psig gas supply pressure	NA	39	70	131	310

Source: Compiled by ICF from vendor supplied data

3.4.2 Heat Recovery

The economics of gas turbines as CHP in process applications are highly dependent on effective use of the thermal energy contained in the exhaust gas. **Figure 3-3** provides a schematic representation of a gas turbine generator with exhaust heat recovery transferring energy to a heat recovery steam generator (HRSG) that can provide steam for process use or to drive a steam turbine generator. Thermal energy generally represents 60 to 70 percent of the inlet fuel energy. The most common use of this energy is for steam generation in unfired or supplementary fired heat recovery steam generators. However, the gas turbine exhaust gases can also be used as a source of direct process energy, for unfired or fired process fluid heaters, or as preheated combustion air for power boilers. An unfired HRSG is the simplest steam CHP configuration and can generate steam up to approximately 1,200 psig.

Figure 3-3. Heat Recovery from a Gas Turbine System

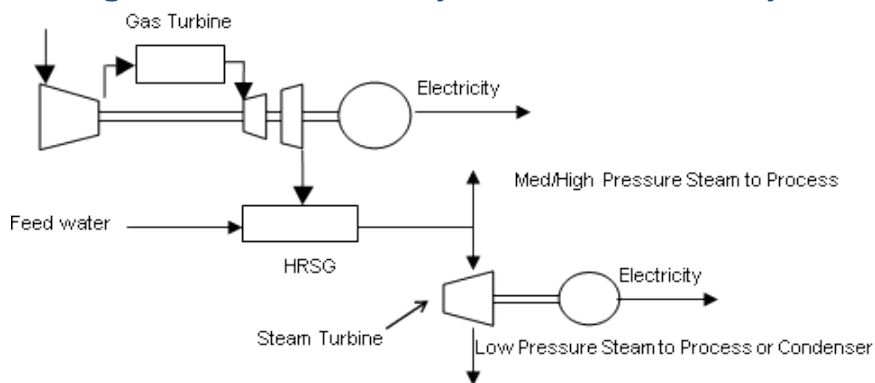

As the quality of the steam required satisfying a thermal load increases, the overall system efficiency decreases. Even with a counter-flow heat exchanger, the HRSG stack temperature increases when the steam quality increases. For the Solar Taurus 70, an overall efficiency of 80.5 percent is possible with a HRSG producing 15 psig steam (LHV basis). A system producing 900 psig steam has an overall efficiency

⁴⁸ Fuel gas supply pressure requirements calculated assuming delivery of natural gas at an absolute pressure 35 percent greater than the compressor discharge in order to meet the requirements of the gas turbine flow control system and combustor mixing nozzles. Mass flow of fuel based on the fuel flow of reference gas turbines in the size range considered, and assuming an electric motor of 95 percent efficiency driving the booster compressor. Gas supply pressures of 50 psig, 150 psig and 250 psig form the basis of the calculations.

of 72.8 percent (LHV basis.) The low pressure steam can extract the exhaust energy down to a HRSG stack temperature of 275 °F; for the high (900 psig) steam requirement, energy can only be extracted down to a HRSG stack temperature of 380 °F.⁴⁹

Overall CHP efficiency generally remains high under part load conditions because the lower efficiencies of electric generation at part load create more heat available for recovery steam making. The same low pressure steam system described above has an overall efficiency at 50 percent output that is virtually unchanged from full load operation even though the generation efficiency has dropped from 32.8 percent to 24.8 percent (LHV basis.) However, at 50 percent load the power to heat ratio has dropped from the full load value of 0.70 to 0.46 indicating that a much higher share of the total energy recovered is in the form of heat.

Gas turbines operate with a high degree of excess air compared to the stoichiometric ratio⁵⁰ required for combustion of the input fuel. Turbine exhaust is typically about 15 percent oxygen. Since very little of the available oxygen in the turbine air flow is used in the combustion process, the oxygen content in the gas turbine exhaust permits supplementary fuel firing ahead of the HRSG to increase steam production relative to an unfired unit. Supplementary firing can raise the exhaust gas temperature entering the HRSG up to a maximum of 2,800°F and increase the amount of steam produced by the unit by more than a factor of four. Moreover, since the turbine exhaust gas is essentially preheated combustion air, the fuel consumed in supplementary firing is less than that required for a stand-alone boiler providing the same increment in steam generation. The HHV efficiency of incremental steam production from supplementary firing above that of an unfired HRSG is often 85 percent or more when firing natural gas.

Supplementary firing also increases system flexibility. Unfired HRSGs are typically convective heat exchangers that respond solely to exhaust conditions of the gas turbine and do not easily allow for steam flow control. Supplementary firing capability provides the ability to control steam production, within the capability of the burner system, independent of the normal gas turbine operating mode. Low NO_x duct burners with guaranteed emissions levels as low as 0.08 lb NO_x/MMBtu can be specified to minimize the NO_x contribution of supplemental firing.

3.4.3 Part-Load Performance

When less than full power is required from a gas turbine, the output is reduced by lowering the turbine inlet temperature. In addition to reducing power, this change in operating conditions also reduces efficiency. **Figure 3-4** shows a typical part-load derate curve. Emissions are generally increased at part load conditions, especially at half load and below.

⁴⁹ Vendor supplied performance data.

⁵⁰ The stoichiometric ratio refers to the amount of one reactant necessary to completely react with other reactant, without having any input leftover once the reaction has completed.

Figure 3-4. Effect of Part Load Operation on Electrical Efficiency

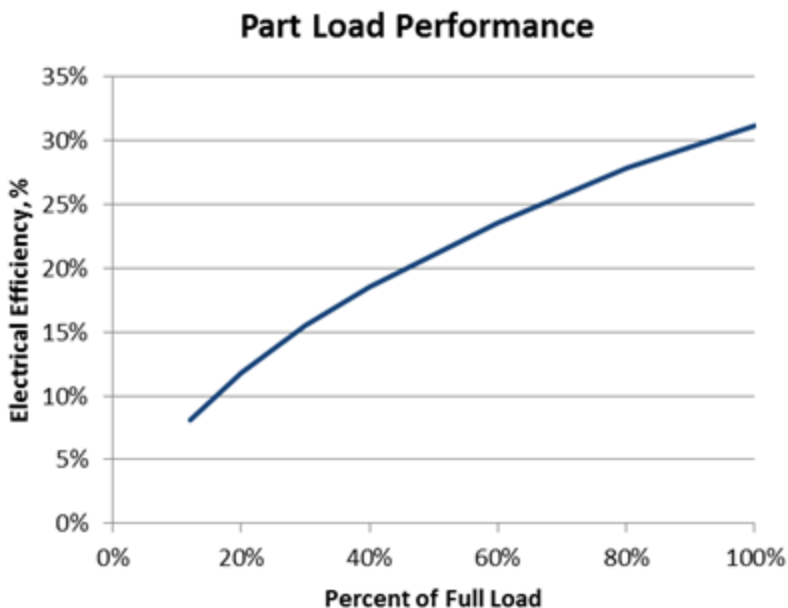

Source: Solar Turbines, Mars 100⁵¹

3.4.4 Effects of Ambient Conditions on Performance

3.4.4.1 Ambient Air Temperature

The ambient conditions under which a gas turbine operates have a noticeable effect on both the power output and efficiency. At elevated inlet air temperatures, both the power and efficiency decrease. The power decreases due to the decreased air flow mass rate (the density of air declines as temperature increases), and the efficiency decreases because the compressor requires more power to compress air of higher temperature. Conversely, the power and efficiency increase when the inlet air temperature is reduced. **Figure 3-5** shows the variation in power and efficiency for the nominal 7.5 MW Solar Taurus 70 gas turbine as a function of ambient temperature. ISO rating conditions for gas turbines are at sea level and 59 °F. Compared to this rating point, power output drops to 80 percent at 100 °F and increases to 107 percent at 40 °F. The corresponding efficiency effects are down 8 percent and up 2 percent for 100 and 40 °F respectively. The effects of ambient temperature on output and efficiency need to be considered in the design and evaluation of a gas turbine CHP system because in many parts of the country, electric prices are highest in the summer when performance of the system is at its lowest.

⁵¹ "Mars 100 Gas Turbine Generator Set", Solar Turbines A Caterpillar Company.
<https://mysolar.cat.com/cda/files/126902/7/ds100pg.pdf>

Figure 3-5. Effect of Ambient Temperature on Capacity and Efficiency

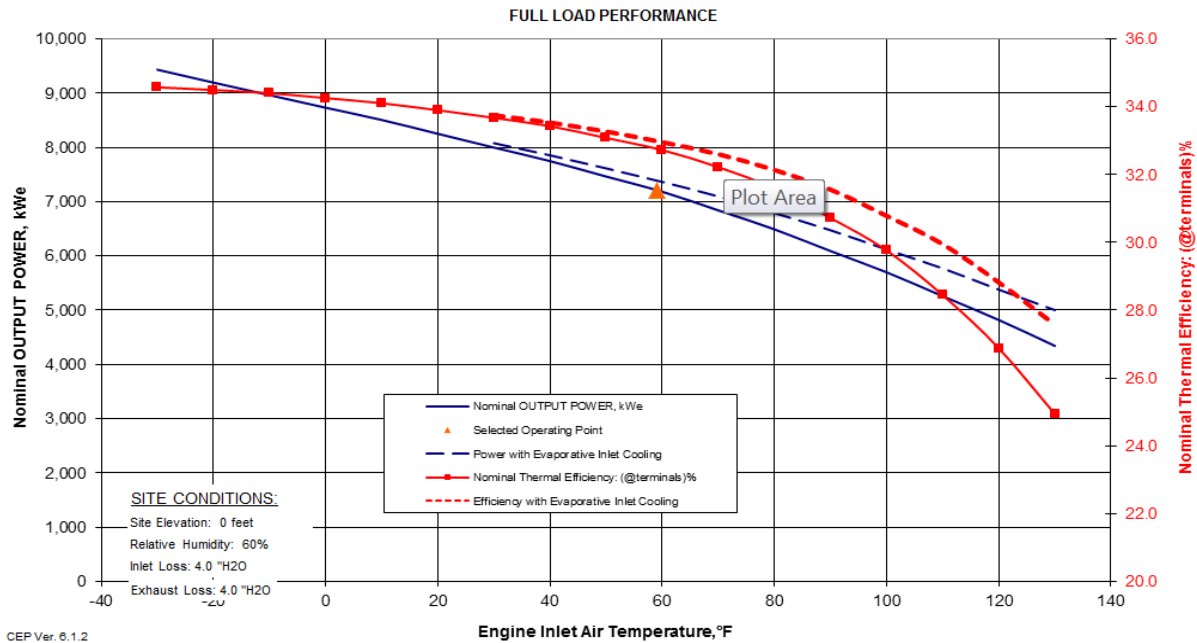

Source: Solar Turbines, Taurus 70⁵²

Figure 3-5 also shows how inlet air cooling can help to moderate the loss of power and efficiency at higher ambient temperatures. The figure shows that cooling the air entering the turbine by 40 to 50°F on a hot day can increase power output by 15 to 20 percent. The decreased power and efficiency resulting from high ambient air temperatures can be mitigated by any of several approaches to inlet-air cooling, including refrigeration, evaporative cooling, and thermal-energy storage using off-peak cooling.

With refrigeration cooling, either a compression driven or thermally activated (absorption chiller) refrigeration cycle cools the inlet air through a heat exchanger. The heat exchanger in the inlet air stream causes an additional pressure drop in the air entering the compressor, thereby slightly lowering cycle power and efficiency. However, as the inlet air is now substantially cooler than the ambient air there is a significant net gain in power and efficiency. Electric motor compression refrigeration requires a substantial parasitic power loss. Thermally activated absorption cooling can utilize waste heat from the gas turbine, reducing the direct parasitic loss. However, the complexity and cost of this approach pose potential drawbacks in many applications.

Evaporative cooling, which is widely used due to its low capital cost, uses a spray of water directly into the inlet air stream. Evaporation of the water reduces the temperature of the air. Since cooling is limited to the wet bulb air temperature, evaporative cooling is most effective when the wet bulb temperature is appreciably below the dry bulb (ordinary) temperature. Evaporative cooling can consume large

⁵² "Taurus 70 Gas Turbine Generator Set", Solar Turbines A Caterpillar Company. <https://mysolar.cat.com/cda/files/1987672/7/ds70gs.pdf>

quantities of water, making it difficult to operate in arid climates. A few large gas turbines have evaporative cooling, which is expected to be used more frequently on smaller machines in the future.

The use of thermal-energy storage systems, such as ice, chilled water, or low-temperature fluids, to cool inlet air can eliminate most parasitic losses from the augmented power capacity. Thermal energy storage is a viable option if on-peak power pricing only occurs a few hours a day. In that case, the shorter time of energy storage discharge and longer time for daily charging allow for a smaller and less expensive thermal-energy storage system.

3.4.4.2 Site Altitude

The density of air decreases at altitudes above sea level reducing the mass of air that the compressor section of the turbine can introduce into the combustor. The reduced mass of air flow produces a corresponding reduction in the power (capacity) that the turbine can generate as shown in **Figure 3-6**. The percentage power reduction is the same for all turbines and is not dependent on the turbine size or the pressure ratio of the compressor. Unlike the effects of increased ambient temperature, which also produces a reduction in the efficiency of electricity production, altitude changes have only a very slight impact on efficiency.

Figure 3-6. The Effect of Altitude on Gas Turbine Capacity

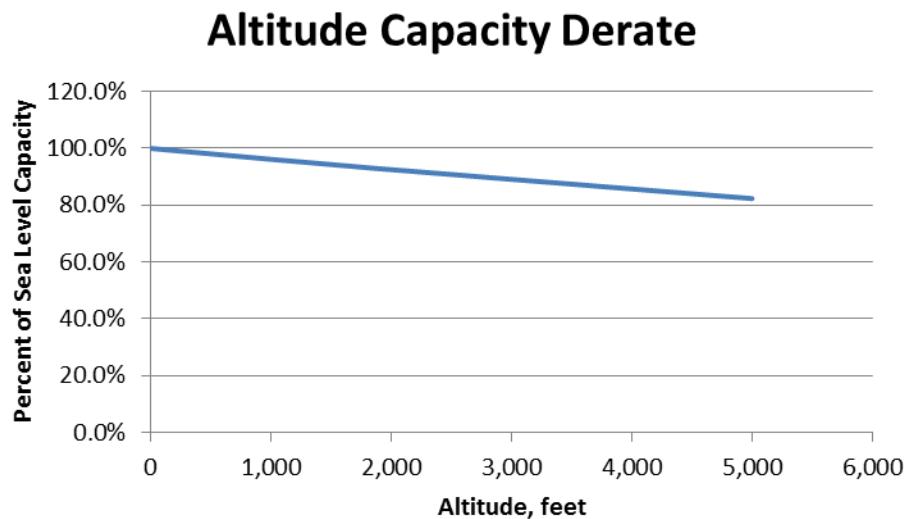

3.4.5 Capital Costs

A gas turbine CHP plant is a complex process with many interrelated subsystems. The basic package consists of the gas turbine, gearbox, electric generator, inlet and exhaust ducting, inlet air filtration, lubrication and cooling systems, standard starting system, and exhaust silencing. The basic package cost does not include extra systems such as the fuel-gas compressor, heat-recovery system, water-treatment system, or emissions-control systems such as selective catalytic reduction (SCR) or continuous emission monitoring systems (CEMS). Not all of these systems are required at every site. The cost of the basic

turbine package plus the costs for added systems needed for the particular application comprise the total equipment cost.

Installed capital costs can vary significantly depending on the scope of the plant equipment, geographical area, competitive market conditions, special site requirements, emissions control requirements, prevailing labor rates, whether the system is a new or retrofit application, and whether the site is a greenfield, or is located at an established industrial site with existing roads, water, fuel, electric, etc. The cost estimates presented here are meant to represent a basic installation at an established site. The parameters for the cost estimation are shown in **Table 3-4**.

Table 3-4. Cost Estimation Parameters

Site Conditions	
Fuel	Pipeline quality natural gas
Altitude, temp, RH	ISO rating conditions
Inlet and Outlet Pressure Drop	As operated for CHP with HRSG and SCR
Site Fuel Gas Pressure	55 psig (gas compression required)
Steam Requirements	Max unfired steam flow, 150 lbs, saturated
Condensate Conditions	60% condensate return
	212° F condensate return
	70° F makeup water
Emissions Requirements	Dry Low NO _x combustion with SCR/CO/CEMS
Scope of Supply	
Project Management	Engineer, procure, construct, manage
Civil	Buildable site with infrastructure available
Electrical	Switchgear, interconnection, control, transformer
Fuel System	Fuel gas compressor, fuel gas filter, regulator, heater
Building	Building at \$100/square foot
Steam System	Assume the CHP system is tying into an existing steam system with existing water treatment, de-aerator, and feed-water pumps

Table 3-5 details estimated capital costs (equipment and installation costs) for the five representative gas turbine CHP systems. The table shows that there are definite economies of scale for larger turbine power systems. Turbine packages themselves decline in cost only slightly between the range of 5 to 40 MW, but ancillary equipment such as the HRSG, gas compression, water treatment, and electrical equipment are much lower in cost per unit of electrical output as the systems become larger.

Table 3-5. Estimated Capital Cost for Representative Gas Turbine CHP Systems⁵³

Cost Component	System				
	1	2	3	4	5
Nominal Turbine Capacity (kW)	3,510	7,520	10,680	21,730	45,607
Net Power Output (kW)	3,304	7,038	9,950	20,336	44,488
Equipment					
Combustion Turbines	\$2,869,400	\$4,646,000	\$7,084,400	\$12,242,500	\$23,164,910
Electrical Equipment	\$1,051,600	\$1,208,200	\$1,304,100	\$1,490,300	\$1,785,000
Fuel System	\$750,400	\$943,000	\$1,177,300	\$1,708,200	\$3,675,000
Heat Recovery Steam Generators	\$729,500	\$860,500	\$1,081,000	\$1,807,100	\$3,150,000
SCR, CO, and CEMS	\$688,700	\$943,200	\$983,500	\$1,516,400	\$2,625,000
Building	\$438,500	\$395,900	\$584,600	\$633,400	\$735,000
Total Equipment	\$6,528,100	\$8,996,800	\$12,214,900	\$19,397,900	\$35,134,910
Installation					
Construction	\$2,204,000	\$2,931,400	\$3,913,700	\$6,002,200	\$10,248,400
Total Installed Capital	\$8,732,100	\$11,928,200	\$16,128,600	\$25,400,100	\$45,383,310
Other Costs					
Project/Construction Management	\$678,100	\$802,700	\$1,011,600	\$1,350,900	\$2,306,600
Shipping	\$137,600	\$186,900	\$251,300	\$394,900	\$674,300
Development Fees	\$652,800	\$899,700	\$1,221,500	\$1,939,800	\$3,312,100
Project Contingency	\$400,700	\$496,000	\$618,500	\$894,200	\$1,526,800
Project Financing	\$238,500	\$322,100	\$432,700	\$899,400	\$2,303,500
Total Installed Cost					
Total Plant Cost	\$10,839,800	\$14,635,600	\$19,664,200	\$30,879,300	\$55,506,610
Installed Cost, \$/kW	\$3,281	\$2,080	\$1,976	\$1,518	\$1,248

Source: Compiled by ICF from vendor-supplied data.

3.4.6 Maintenance

Non-fuel operation and maintenance (O&M) costs are presented in **Table 3-6**. These costs are based on gas turbine manufacturer estimates for service contracts, which consist of routine inspections and scheduled overhauls of the turbine generator set. Routine maintenance practices include on-line running maintenance, predictive maintenance, plotting trends, performance testing, fuel consumption, heat rate, vibration analysis, and preventive maintenance procedures. The O&M costs presented in **Table 3-6** include operating labor (distinguished between unmanned and 24 hour manned facilities) and total maintenance costs, including routine inspections and procedures and major overhauls.

⁵³ Combustion turbine costs are based on published specifications and package prices. Installation estimates are based on vendor cost estimation models and developer-supplied information.

Table 3-6. Gas Turbine Non-Fuel O&M Costs

Cost Component	System				
	1	2	3	4	5
Net Operating Capacity (kW)	3,304	7,038	9,950	20,336	44,488
Turbine O&M (\$/kWh)	\$0.0090	\$0.0090	\$0.0089	\$0.0062	\$0.0062
BOP O&M (\$/kWh)	\$0.0036	\$0.0033	\$0.0031	\$0.0031	\$0.0030
Total O&M (\$/kWh)	\$0.0126	\$0.0123	\$0.0120	\$0.0093	\$0.0092

Source: Compiled by ICF from vendor-supplied data

Daily maintenance includes visual inspection by site personnel of filters and general site conditions. Typically, routine inspections are required every 4,000 hours to insure that the turbine is free of excessive vibration due to worn bearings, rotors, and damaged blade tips. Inspections generally include on-site hot gas path boroscope inspections and non-destructive component testing using dye penetrant and magnetic particle techniques to ensure the integrity of components. The combustion path is inspected for fuel nozzle cleanliness and wear, along with the integrity of other hot gas path components.

A gas turbine overhaul is needed every 25,000 to 50,000 hours depending on service and typically includes a complete inspection and rebuild of components to restore the gas turbine to nearly original or current (upgraded) performance standards. A typical overhaul consists of dimensional inspections, product upgrades and testing of the turbine and compressor, rotor removal, inspection of thrust and journal bearings, blade inspection and clearances and setting packing seals.

Gas turbine maintenance costs can vary significantly depending on the quality and diligence of the preventative maintenance program and operating conditions. Although gas turbines can be cycled, cycling every hour triples maintenance costs versus a turbine that operates for intervals of 1,000 hours or more. In addition, operating the turbine over the rated capacity for significant periods of time will dramatically increase the number of hot path inspections and overhauls. Gas turbines that operate for extended periods on liquid fuels will experience shorter than average overhaul intervals.

3.4.7 Fuels

All gas turbines intended for service as stationary power generators in the United States are available with combustors equipped to handle natural gas fuel. A typical range of heating values of gaseous fuels acceptable to gas turbines is 900 to 1,100 Btu per standard cubic foot (scf), which covers the range of pipeline quality natural gas. Clean liquid fuels are also suitable for use in gas turbines.

Special combustors developed by some gas turbine manufacturers are capable of handling cleaned gasified solid and liquid fuels. Burners have been developed for medium Btu fuel (in the 400 to 500 Btu/scf range), which is produced with oxygen-blown gasifiers, and for low Btu fuel (90 to 125 Btu/scf), which is produced by air-blown gasifiers. These burners for gasified fuels exist for large gas turbines but are not available for small gas turbines.

Contaminants in fuel such as ash, alkalis (sodium and potassium), and sulfur result in alkali sulfate deposits, which impede flow, degrade performance, and cause corrosion in the turbine hot section.

Fuels must have only low levels of specified contaminants in them (typically less than 10 ppm total alkalis, and single-digit ppm of sulfur).

Liquid fuels require their own pumps, flow control, nozzles and mixing systems. Many gas turbines are available with either gas or liquid firing capability. In general, gas turbines can convert for use with one fuel to another quickly. Several gas turbines are equipped for dual firing and can switch fuels with minimal or no interruption.

Lean burn/dry low NO_x gas combustors generate NO_x emissions levels as low as 9 ppm (at 15 percent O₂). Liquid fuel combustors have NO_x emissions limited to approximately 25 ppm (at 15 percent O₂). There is no substantial difference in general performance with either fuel. However, the different heats of combustion result in slightly higher mass flows through the expansion turbine when liquid fuels are used, and thus result in a small increase in power and efficiency performance. In addition, the fuel pump work with liquid fuel is less than with the fuel gas booster compressor, thereby further increasing net performance with liquid fuels.

3.4.8 Gas Turbine System Availability

Operational conditions affect the failure rate of gas turbines. Frequent starts and stops incur damage from thermal cycling, which accelerates mechanical failure. The use of liquid fuels, especially heavy fuels and fuels with impurities (alkalis, sulfur, and ash), radiates heat to the combustor walls significantly more intensely than the use of clean, gaseous fuels, thereby overheating the combustor and transition piece walls. On the other hand, steady operation on clean fuels can permit gas turbines to operate for a year without need for shutdown. Based on a survey of 41 operating gas turbine systems shown in **Table 3-7**, the average availability of gas turbines operating on clean gaseous fuels, like natural gas, is around 95 percent.

Table 3-7. Gas Turbine Availability and Outage Rates

Gas Turbines	0.5 to 3 MW	3 to 20 MW	20 to 100 MW
Systems Surveyed	11	21	9
Availability, %	96.12%	94.73%	93.49%
Forced Outage Rate, %	2.89%	2.88%	1.37%
Scheduled Outage Rate, %	0.99%	2.39%	5.14%

Source: ICF

3.5 Emissions and Emissions Control Options

3.5.1 Emissions

Table 3-8 shows typical emissions for each of the five typical turbine systems. Typical emissions presented are based on natural gas combustion showing emissions before and after exhaust treatment using SCR and CO oxidation.

Table 3-8. Gas Turbine Emissions Characteristics

Emissions Characteristics	System				
	1	2	3	4	5
Electricity Capacity (kW)	3,304	7,038	9,950	20,336	44,488
Electrical Efficiency (HHV)	24.0%	28.9%	27.3%	33.3%	36.0%
Emissions Before After-treatment					
NO _x (ppm)	25	15	15	15	15
NO _x (lb/MWh)	1.31	0.65	0.69	0.57	0.52
CO (ppmv)	50	25	25	25	25
CO (lb/MWh)	1.60	0.66	0.70	0.58	0.53
NMHC (ppm)	5	5	5	5	5
NMHC (lb/MWh)	0.09	0.08	0.08	0.07	0.06
Emissions with SCR/CO/CEMS					
NO _x (ppm)	2.5	1.5	1.5	1.5	1.5
NO _x (lb/MWh)	0.09	0.05	0.05	0.05	0.05
CO (ppmv)	5.0	2.5	2.5	2.5	2.5
CO (lb/MWh)	0.11	0.05	0.05	0.05	0.05
NMHC (ppm)	4.3	4.3	4.3	4.3	2.0
NMHC (lb/MWh)	0.08	0.06	0.07	0.06	0.02
CO₂ Emissions					
Generation CO ₂ (lb/MWh)	1,667	1,381	1,460	1,201	1,110
Net CO ₂ with CHP (lb/MWh)	797	666	691	641	654

Source: Compiled by ICF from vendor supplied data, includes heat recovery

Table 3-8 also shows the net CO₂ emissions after credit is taken for avoided natural gas boiler fuel. The net CO₂ emissions range from 641-797 lbs/MWh. A natural gas combined cycle power plant might have emissions in the 800-900 lb/MWh range whereas a coal power plant’s CO₂ emissions would be over 2000 lb/MWh. Natural gas fired CHP from gas turbines provides savings against both alternatives.

3.5.2 Emissions Control Options

Emissions control technology for gas turbines has advanced dramatically over the last 20 years in response to technology forcing requirements that have continually lowered the acceptable emissions levels for nitrogen oxides (NO_x), carbon monoxide (CO), and volatile organic compounds (VOCs). When burning fuels other than natural gas, pollutants such as oxides of sulfur (SO_x) and particulate matter (PM) can be an issue. In general, SO_x emissions are greater when heavy oils are fired in the turbine. SO_x control is generally addressed by the type of fuel purchased, than by the gas turbine technology. Particulate matter is a marginally significant pollutant for gas turbines using liquid fuels. Ash and metallic additives in the fuel may contribute to PM in the exhaust.

A number of control options can be used to control emissions. Below are descriptions of these options.

3.5.2.1 Diluent Injection

The first technique used to reduce NO_x emissions was injection of water or steam into the high temperature flame zone. Water and steam are strong diluents and can quench hot spots in the flame reducing NO_x. However, because positioning of the injection is not precise some NO_x is still created. Depending on uncontrolled NO_x levels, water or steam injection reduces NO_x by 60 percent or more. Water or steam injection enables gas turbines to operate with NO_x levels as low as 25 ppm (@ 15 percent O₂) on natural gas. NO_x is reduced only to 42 to 75 ppm when firing with liquid distillate fuel. Both water and steam increase the mass flow through the turbine and create a small amount of additional power. Use of exhaust heat to raise the steam temperature also increases overall efficiency slightly. The water used needs to be demineralized thoroughly in order to avoid forming deposits and corrosion in the turbine expansion section. This adds cost and complexity to the operation of the turbine. Diluent injection increases CO emissions appreciably as it lowers the temperature in the burnout zone, as well as in the NO_x formation zone.

3.5.2.2 Lean Premixed Combustion

Lean premixed combustion (DLN/DLE⁵⁴) pre-mixes the gaseous fuel and compressed air so that there are no local zones of high temperatures, or "hot spots," where high levels of NO_x would form. Lean premixed combustion requires specially designed mixing chambers and mixture inlet zones to avoid flashback of the flame. Optimized application of DLN combustion requires an integrated approach for combustor and turbine design. The DLN combustor becomes an intrinsic part of the turbine design, and specific combustor designs must be developed for each turbine application. While NO_x levels as low as 9 ppm have been achieved, most manufacturers typically offer a range of 15-25 ppm DLN/DLE combustion systems when operating on natural gas.

3.5.2.3 Selective Catalytic Reduction (SCR)

The primary post-combustion NO_x control method in use today is SCR. Ammonia is injected into the flue gas and reacts with NO_x in the presence of a catalyst to produce N₂ and H₂O. The SCR system is located in the exhaust path, typically within the HRSG where the temperature of the exhaust gas matches the operating temperature of the catalyst. The operating temperature of conventional SCR systems ranges from 400 to 800°F. The cost of conventional SCR has dropped significantly over time—catalyst innovations have been a principal driver, resulting in a 20 percent reduction in catalyst volume and cost with no change in performance. SCR reduces between 80 to 90 percent of the NO_x in the gas turbine exhaust, depending on the degree to which the chemical conditions in the exhaust are uniform. When used in series with water/steam injection or DLN combustion, SCR can result in low single digit NO_x levels (1.5 to 5 ppm). SCR requires on-site storage of ammonia, a hazardous chemical. In addition, ammonia can "slip" through the process unreacted, contributing to environmental and health concerns.⁵⁵

⁵⁴ Dry low NO_x/Dry low emissions

⁵⁵ The SCR reaction, with stoichiometric ammonia (for NO_x reduction) or other reagent should eliminate all NO_x. However, because of imperfect mixing in the combustor the NO_x is not uniformly distributed across the turbine exhaust. Additionally, the ammonia, or other reagent, also is not injected in a precisely uniform manner. These two non-uniformities in chemical composition cause either excess ammonia to be used, and to consequently "slip" out of the exhaust, or for incomplete reaction of the NO_x in the turbine exhaust.

3.5.2.4 CO Oxidation Catalysts

Oxidation catalysts control CO in gas turbine exhaust. Some SCR installations incorporate CO oxidation modules along with NO_x reduction catalysts for simultaneous control of CO and NO_x. The CO catalyst promotes the oxidation of CO and hydrocarbon compounds to CO₂ and water as the exhaust stream passes through the catalyst bed. The oxidation process takes place spontaneously so no reactants are required. The catalyst is usually made of precious metal such as platinum, palladium, or rhodium. Other formations, such as metal oxides for emission streams containing chlorinated compounds, are also used. CO catalysts also reduce VOCs and organic hazardous air pollutants (HAPs). CO catalysts on gas turbines result in approximately 90 percent reduction of CO and 85 to 90 percent control of formaldehyde (similar reductions can be expected on other HAPs).

3.5.2.5 Catalytic Combustion

Catalytic combustion systems oxidize the fuel at lean conditions in the presence of a catalyst. Catalytic combustion is a flameless process, allowing fuel oxidation to occur at temperatures below 1,700°F, where NO_x formation is low. The catalyst is applied to combustor surfaces, which cause the fuel air mixture to react with the oxygen and release its initial thermal energy. The combustion reaction in the lean premixed gas then goes to completion at design temperature. Data from ongoing long term testing indicates that catalytic combustion exhibits low vibration and acoustic noise, only one-tenth to one-hundredth the levels measured in the same turbine equipped with DLN combustors. Catalytic combustors capable of achieving NO_x levels below 3 ppm are entering commercial production.⁵⁶ Similar to DLN combustion, optimized catalytic combustion requires an integrated approach for combustor and turbine design. Catalytic combustors must be tailored to the specific operating characteristics and physical layout of each turbine design.

3.5.2.6 Catalytic Absorption Systems

SCONO_xTM, patented by Goal Line Environmental Technologies (currently EmerChem), is a post-combustion alternative to SCR that reduces NO_x emissions to less than 2.5 ppm and almost 100 percent removal of CO. SCONO_xTM combines catalytic conversion of CO and NO_x with an absorption/regeneration process that eliminates the ammonia reagent found in SCR technology. It is based on a unique integration of catalytic oxidation and absorption technology. CO and NO catalytically oxidize to CO₂ and NO₂. The NO₂ molecules are subsequently absorbed on the treated surface of the SCONO_xTM catalyst. The system does not require the use of ammonia, eliminating the potential for ammonia slip associated with SCR. The SCONO_xTM system is generally located within the HRSG, and under special circumstances may be located downstream of the HRSG. The system operates between 300-700°F. U.S. EPA Region 9 identified SCONO_xTM as “Lowest Achievable Emission Rate (LAER)” technology for gas turbine NO_x control in 1998. The SCONO_xTM technology is still in the early stages of market introduction. Issues that may impact application of the technology include relatively high capital cost, large reactor size compared to SCR, system complexity, high utilities cost and demand (steam, natural gas, compressed air and electricity are required), and a gradual rise in NO emissions over time that requires a 1 to 2 day

⁵⁶ For example, Kawasaki offers a version of their M1A 13X, 1.4 MW gas turbine with a catalytic combustor with less than 3 ppm NO_x guaranteed.

shutdown every 6 to 12 months (depending on fuel quality and operation) to remove and regenerate the absorption modules ex-situ.⁵⁷

3.6 Future Developments

In the last twenty years, there have been substantial improvement in gas turbine technology with respect to power, efficiency, durability, green operation, and time/cost to market. These improvements have been the combined results of collaborative research efforts by private industry, universities, and the federal government. Public private partnerships such as the DOE Advanced Turbine Systems Program and the Next Generation Turbine program have advanced gas turbine technology by meeting goals including:

- Combined cycle electric efficiency of 60 percent (LHV)
- NO_x emissions of less than 10 ppm
- 10 percent reduction in the cost of electricity
- Improvement in reliability, availability, and maintainability (RAM)
- Development of the recuperated 4.6 MW Solar Mercury gas turbine with low emissions and electrical efficiency of 37.5 percent (LHV) compared to an unrecuperated gas turbine of similar size having an electric efficiency of 28.5 percent

Current collaborative research is focusing on both large gas turbines and those applicable for distributed generation. Large gas turbine research is focused on improving the efficiency of combined cycle plants to 65 percent (LHV), reducing emission even further, and integrating gas turbines with clean coal gasification and carbon capture. The focus for smaller gas turbines is on improving performance, enhancing fuel flexibility, reducing emissions, reducing life cycle costs, and integration with improved thermal utilization technologies. Continued development of aeroderivative gas turbines for civilian and military propulsion will provide carryover benefits to stationary applications.

Long term research includes the development of hybrid gas turbine fuel cell technology that is capable of 70 percent (LHV) electric efficiency.⁵⁸

⁵⁷ Resource Catalysts, Inc.

⁵⁸ DOE turbine/fuel cell hybrid program, <http://www.netl.doe.gov/technologies/coalpower/fuelcells/hybrids.html>

Section 4. Technology Characterization – Steam Turbines

4.1 Introduction

Steam turbines are one of the most versatile and oldest prime mover technologies still in general production used to drive a generator or mechanical machinery. The first steam turbine used for power generation was invented in 1884. Following this initial introduction, steam turbines rapidly replaced reciprocating steam engines due to their higher efficiencies and lower costs. Most of the electricity produced in the United States today is generated by conventional steam turbine power plants. The capacity of steam turbines can range from 50 kW to several hundred MWs for large utility power plants. Steam turbines are widely used for combined heat and power (CHP) applications in the United States and Europe.

Unlike gas turbine and reciprocating engine CHP systems, where heat is a byproduct of power generation, steam turbine generators normally generate electricity as a byproduct of heat (steam) generation. A steam turbine is captive to a separate heat source and does not directly convert fuel to electric energy. The energy is transferred from the boiler to the turbine through high pressure steam that powers the turbine and generator. This separation of functions enables steam turbines to operate using a large variety of fuels, from clean natural gas to solid waste, including all types of coal, wood, wood waste, and agricultural byproducts (sugar cane bagasse, fruit pits and rice hulls). In CHP applications, steam at lower pressure is extracted from the steam turbine and used directly in a process or for district heating, or it can be converted to other forms of thermal energy including hot or chilled water.

Steam turbines offer a wide array of designs and complexity to match the desired application and/or performance specifications ranging from single stage backpressure or condensing turbines for low power ranges to complex multi-stage turbines for higher power ranges. Steam turbines for utility service may have several pressure casings and elaborate design features, all designed to maximize the efficiency of the power plant. For industrial applications, steam turbines are generally of simpler single casing design and less complicated for reliability and cost reasons. CHP can be adapted to both utility and industrial steam turbine designs.

Table 4-1 provides a summary of steam turbine attributes described in detail in this chapter.

Table 4-1. Summary of Steam Turbine Attributes

Size range	Steam turbines are available in sizes from under 100 kW to over 250 MW. In the multi-megawatt size range, industrial and utility steam turbine designations merge, with the same turbine (high pressure section) able to serve both industrial and small utility applications.
Custom design	Steam turbines can be designed to match CHP design pressure and temperature requirements. The steam turbine can be designed to maximize electric efficiency while providing the desired thermal output.

Table 4-1. Summary of Steam Turbine Attributes

Thermal output	Steam turbines are capable of operating over a very broad range of steam pressures. Utility steam turbines operate with inlet steam pressures up to 3500 psig and exhaust at vacuum conditions as low as 2 psia. Steam turbines can be custom designed to deliver the thermal requirements of the CHP application through use of backpressure or extraction steam at appropriate pressures and temperatures.
Fuel flexibility	Steam turbines offer a wide range of fuel flexibility using a variety of fuel sources in the associated boiler or other heat source, including coal, oil, natural gas, wood and waste products, in addition to waste exhaust heat recaptured in a heat recovery steam generator.
Reliability and life	Steam turbine equipment life is extremely long. There are steam turbines that have been in service for over 50 years. When properly operated and maintained (including proper control of boiler water chemistry and ensuring dry steam), steam turbines are extremely reliable with overhaul intervals measured in years. Larger turbines require controlled thermal transients as the massive casing heats up slowly and differential expansion of the parts must be minimized. Smaller turbines generally do not have start-up restrictions.

4.2 Applications

Steam turbines are well suited to medium- and large-scale industrial and institutional applications, where inexpensive fuels, such as coal, biomass, solid wastes and byproducts (e.g., wood chips), refinery residual oil, and refinery off gases are available. Applications include:

- **Combined heat and power** – Steam turbine-based CHP systems are primarily used in industrial processes where solid or waste fuels are readily available for boiler use. In CHP applications, steam may be extracted or exhausted from the steam turbine and used directly. Steam turbine systems are very commonly found in paper mills as there is usually a variety of waste fuels from hog fuel to black liquor. Chemical plants are the next most common industrial user of steam turbines followed by primary metals. There are a variety of other industrial applications including the food industry, particularly sugar and palm oil mills.
- **Mechanical drive** – Instead of producing electric power, the steam turbine may drive equipment such as boiler feedwater pumps, process pumps, air compressors and refrigeration chillers. Such applications, usually accompanied by process use of steam are found in many of the CHP industries described above.
- **District heating and cooling systems** – There are cities and college campuses that have steam district heating systems where adding a steam turbine between the boiler and the distribution system or placing a steam turbine as a replacement for a pressure reducing station may be an attractive application. Often the boiler is capable of producing moderate-pressure steam but the distribution system needs only low pressure steam. In these cases, the steam turbine generates electricity using the higher pressure steam, and discharges low pressure steam into the distribution system. Such facilities can also use steam in absorption chillers to produce chilled water for air conditioning.

- Combined cycle power plants** – The trend in power plant design is to generate power with a gas turbine and use the exhaust heat to generate steam that provides additional power through a steam turbine. Such combined-cycle power plants are capable of achieving electric generation efficiencies of over 50 percent. For large industrial CHP applications, an extraction-condensing type of steam turbine can be used in a combined cycle plant with the steam turbine extracting a portion of the steam for process use. There are many large independent power producers (IPP) using combined cycle power plants operating on natural gas to provide power to the electric grid and steam to one or more industrial customers.

4.3 Technology Description

4.3.1 Basic Process

The thermodynamic cycle for the steam turbine is known as the Rankine cycle. This cycle is the basis for conventional power generating stations and consists of a heat source (boiler) that converts water to high pressure steam. In the steam cycle, water is first pumped to elevated pressure, which is medium to high pressure, depending on the size of the unit and the temperature to which the steam is eventually heated. It is then heated to the boiling temperature corresponding to the pressure, boiled (heated from liquid to vapor), and then most frequently superheated (heated to a temperature above that of boiling). The pressurized steam is expanded to lower pressure in a turbine, then exhausted either to a condenser at vacuum conditions, or into an intermediate temperature steam distribution system that delivers the steam to the industrial or commercial application. The condensate from the condenser or from the industrial steam utilization system is returned to the feedwater pump for continuation of the cycle.

4.3.2 Components

A schematic representation of a steam turbine power system is shown in **Figure 4-1**.

Figure 4-1. Boiler/Steam Turbine System

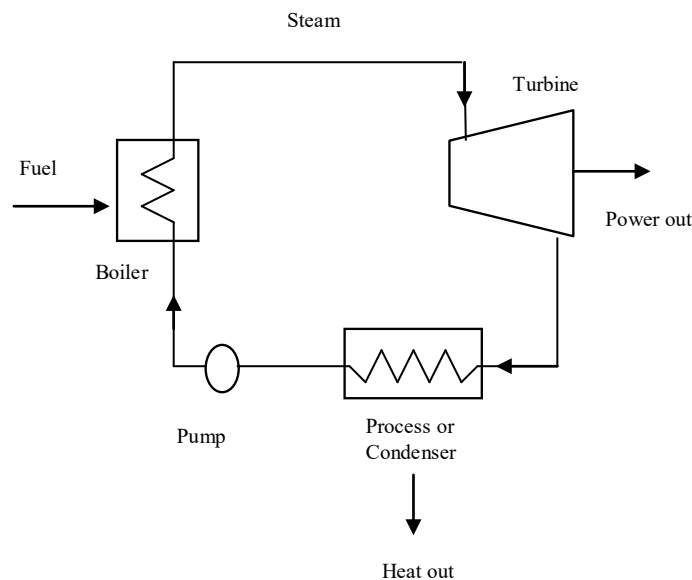

In the simple schematic shown, a fuel boiler produces steam which is expanded in the steam turbine to produce power. When the system is designed for power generation only, such as in a large utility power

system, the steam is exhausted from the turbine at the lowest practical pressure, through the use of a water-cooled condenser to extract the maximum amount of energy from the steam. In CHP plants or district heating systems, the steam is exhausted from the steam turbine at a pressure high enough to be used by the industrial process or the district heating system. In CHP configuration, there is no condenser and the steam and condensate, after exiting the process, is returned to the boiler.

There are numerous options in the steam supply, pressure, temperature and extent, if any, for reheating steam that has been partially expanded from high pressure. Steam systems vary from low pressure lines used primarily for space heating and food preparation, to medium pressure and temperature used in industrial processes and cogeneration, and to high pressure and temperature use in utility power generation. Generally, as the system gets larger the economics favor higher pressures and temperatures, along with their associated heavier walled boiler tubes and more expensive alloys.

4.3.2.1 Boiler

Steam turbines differ from reciprocating engines, internal combustion engines, and gas turbines in that the fuel is burned in a piece of equipment, the boiler, which is separate from the power generation equipment. The energy is transferred from the boiler to the steam turbine generator by an intermediate medium, typically steam under pressure. As mentioned previously, this separation of functions enables steam turbines to operate with an enormous variety of fuels. The topic of boiler fuels, their handling, combustion and the cleanup of the effluents of such combustion is a separate and complex issue that is addressed in the fuels and emissions sections of this report.

For sizes up to (approximately) 40 MW, horizontal industrial boilers are built. This enables them to be shipped via rail car, with considerable cost savings and improved quality, as the cost and quality of factory labor is usually both lower in cost and greater in quality than field labor. Large shop-assembled boilers are typically capable of firing only gas or distillate oil, as there is inadequate residence time for complete combustion of most solid and residual fuels in such designs. Large, field-erected industrial boilers firing solid and residual fuels bear a resemblance to utility boilers except for the actual solid fuel injection. Large boilers usually burn pulverized coal; however, intermediate and small boilers burning coal or solid fuel employ various types of solids feeders.

4.3.2.2 Steam Turbine

In the steam turbine, the steam is expanded to a lower pressure providing shaft power to drive a generator or run a mechanical process.

There are two distinct designs for steam turbines – *impulse* and *reaction* turbines. The difference between these two designs is shown in **Figure 4-2**. On impulse turbines, the steam jets are directed at the turbine's bucket shaped rotor blades where the pressure exerted by the jets causes the rotor to rotate and the velocity of the steam to reduce as it imparts its kinetic energy to the blades. The next series of fixed blades reverses the direction of the steam before it passes to the second row of moving blades. In Reaction turbines, the rotor blades of the reaction turbine are shaped more like airfoils, arranged such that the cross section of the chambers formed between the fixed blades diminishes from the inlet side towards the exhaust side of the blades. The chambers between the rotor blades essentially form nozzles so that as the steam progresses through the chambers its velocity increases while at the

same time its pressure decreases, just as in the nozzles formed by the fixed blades. The competitive merits of these designs are the subject of business competition, as both designs have been sold successfully for well over 75 years.

Figure 4-2. Comparison of Impulse and Reaction Turbine Design

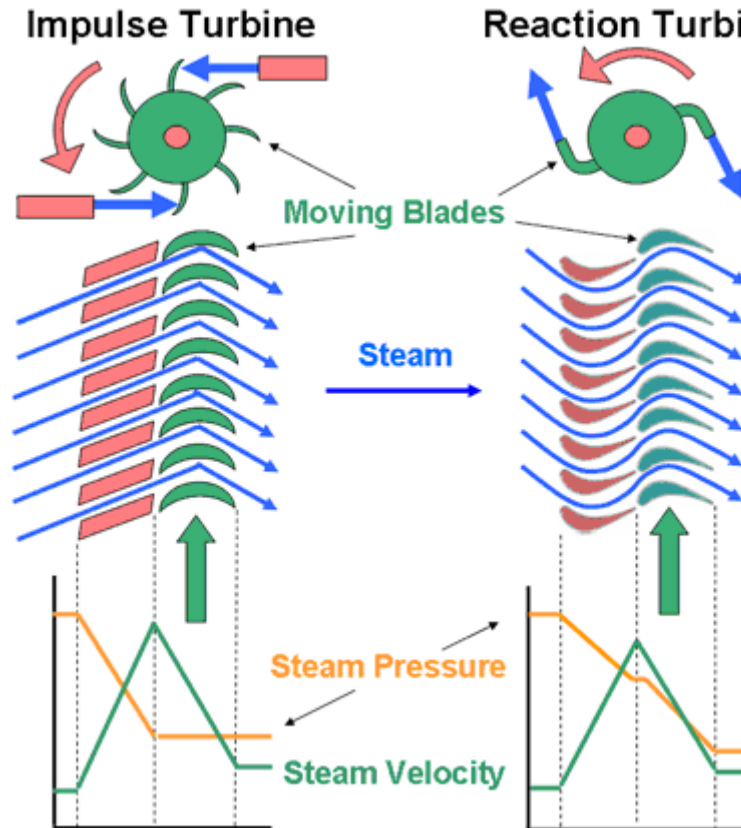

Source: Electropaedia, http://www.mpoweruk.com/steam_turbines.htm

The stationary nozzles accelerate the steam to high velocity by expanding it to lower pressure. A rotating bladed disc changes the direction of the steam flow, thereby creating a force on the blades that, because of the wheeled geometry, manifests itself as torque on the shaft on which the bladed wheel is mounted. The combination of torque and speed is the output power of the turbine. A reduction gear may be utilized to reduce the speed of the turbine to the required output speed for the generator.

The internal flow passages of a steam turbine are very similar to those of the expansion section of a gas turbine (indeed, gas turbine engineering came directly from steam turbine design around 100 years ago). The main differences are gas density, molecular weight, isentropic expansion coefficient, and to a lesser extent, the viscosity of the two fluids.

Compared to reciprocating steam engines of comparable size, steam turbines rotate at much higher rotational speeds, which contribute to their lower cost per unit of power developed. In addition, the inlet and exhaust valves in reciprocating steam engines cause steam pressure losses that don't contribute to power output. Such losses do not occur in steam turbines. As a result of these design

differences, steam turbines are more efficient than reciprocating steam engines operating from the steam at the same inlet conditions and exhausting into the same steam exhaust systems.

There are numerous mechanical design features that have been created to increase efficiency, provide for operation over a range of conditions, simplify manufacture and repair, and achieve other practical purposes. The long history of steam turbine use has resulted in a large inventory of steam turbine stage designs that can be used to tailor a product for a specific application. For example, the division of steam acceleration and change in direction of flow varies between competing turbine manufacturers under the identification of impulse and reaction designs. Manufacturers tailor clients' design requests by varying the flow area in the stages and the extent to which steam is extracted (removed from the flow path between stages) to accommodate the client specifications.

When steam is expanded through a very high pressure ratio, as in utility and large industrial steam systems, the steam can begin to condense in the turbine if the temperature of the steam drops below the saturation temperature at that pressure. If water drops were allowed to form in the turbine, they would impact the blades and would cause blade erosion. At this point in the expansion, the steam is sometimes returned to the boiler and reheated to high temperature and then returned to the turbine for further (safe) expansion. In a few very large, very high-pressure utility steam systems, double reheat systems are installed.

With these choices the designer of the steam supply system and the steam turbine have the challenge of creating a system design which delivers the (seasonally varying) power and steam, that also presents the most favorable business opportunity to the plant owners.

Between the power (only) output of a condensing steam turbine and the power and steam combination of a back pressure steam turbine, essentially any ratio of power to heat output can be supplied to a facility. Moreover, back pressure steam turbines can be obtained with a variety of back pressures, further increasing the variability of the power-to-heat ratio.

4.3.2.3 Condensing Turbine

The primary type of turbine used for central power generation is the condensing turbine shown schematically in **Figure 4-3**. These power-only utility turbines exhaust directly to condensers that maintain vacuum conditions at the discharge of the turbine. An array of tubes, cooled by water from a river, lake or cooling tower, condenses the steam into (liquid) water.⁵⁹ The vacuum conditions in the condenser are caused by the near ambient cooling water causing condensation of the steam turbine exhaust steam in the condenser. As a small amount of air is known to leak into the system when it is below atmospheric pressure, a relatively small compressor or steam air ejector may be used to remove non-condensable gases from the condenser. Non-condensable gases include both air and a small amount of the corrosion byproduct of the water-iron reaction, hydrogen.

⁵⁹ At 80° F, the vapor pressure of water is 0.51 psia, at 100° F it is 0.95 psia, at 120° F it is 1.69 psia and at 140° F Fahrenheit it is 2.89 psia

The condensing turbine processes result in maximum power and electrical generation efficiency from the steam supply and boiler fuel. The power output of condensing turbines is sensitive to ambient conditions.⁶⁰

Figure 4-3. Condensing Steam Turbine

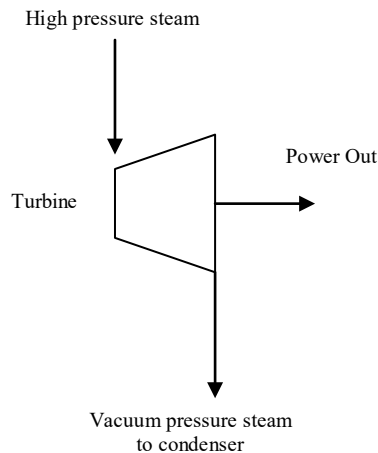

Steam turbines used for CHP can be classified into two main types: non-condensing and extraction, which will be discussed in the following two sections.

4.3.2.4 Non-Condensing (Back-pressure) Turbine

A non-condensing turbine (also referred to as a back-pressure turbine) exhausts some or all of its steam flow to the industrial process or facility steam mains at conditions close to the process heat requirements, as shown in **Figure 4-4**.

Figure 4-4. Non-Condensing (Back-pressure) Steam Turbine

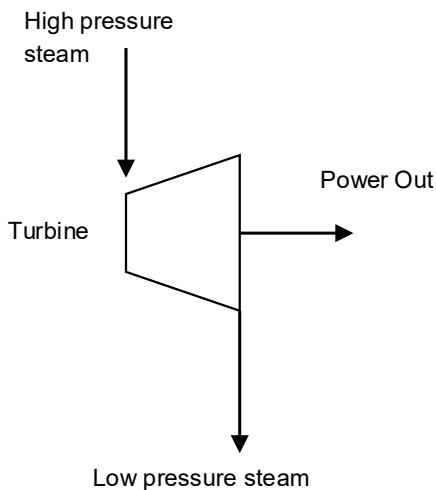

⁶⁰ From a reference condition of condensation at 100° F, 6.5 percent less power is obtained from the inlet steam when the temperature at which the steam is condensed is increased (because of higher temperature ambient conditions) to 115° F. Similarly, the power output is increased by 9.5% when the condensing temperature is reduced to 80° F. This illustrates the influence of steam turbine discharge pressure on power output and, consequently, net heat rate and efficiency.

Usually, the steam sent into the mains is not much above saturation temperature.⁶¹ The term back-pressure refers to turbines that exhaust steam at atmospheric pressures and above. The discharge pressure is established by the specific CHP application. The most typical pressure levels for steam distribution systems are 50, 150, and 250 psig. The lower pressures are most often used in district heating systems, while the higher pressures are most often used in supplying steam to industrial processes. Industrial processes often include further expansion for mechanical drives, using small steam turbines for driving heavy equipment that is intended to run continuously for very long periods. Significant power generation capability is sacrificed when steam is used at high pressure, rather than being expanded to vacuum conditions in a condenser. Discharging steam into a steam distribution system at 150 psig can sacrifice slightly more than half the power (compared to a vacuum exhaust) that could be generated when the inlet steam conditions are 750 psig and 800° F, typical of small steam turbine systems.

4.3.2.5 Extraction Turbine

An extraction turbine has one or more openings in its casing for extraction of a portion of the steam at some intermediate pressure. The extracted steam may be used for process purposes in a CHP facility, or for feedwater heating, as is the case in most utility power plants. The rest of the steam can be expanded to below atmospheric pressure to a condenser, or delivered to a low pressure steam application as illustrated in **Figure 4-5**.

Figure 4-5. Extraction Steam Turbine

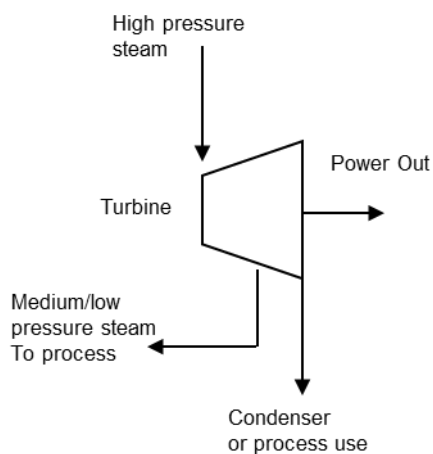

The steam extraction pressure may or may not be automatically regulated depending on the turbine design. Regulated, or controlled extraction permits more steam to flow through the turbine to generate additional electricity during periods of low thermal demand by the CHP system. In utility type steam turbines, there may be several extraction points, each at a different pressure corresponding to a different temperature at which heat is needed in the thermodynamic cycle. The facility's specific needs

⁶¹ At 50 psig (65 psia) the condensation temperature is 298° F, at 150 psig (165 psia) the condensation temperature is 366° F, and at 250 psig (265 psia) it is 406° F.

for steam and power over time determine the extent to which steam in an extraction turbine will be extracted for use in the process, or be expanded to vacuum conditions and condensed in a condenser.

In large, complex industrial plants, additional steam may be admitted to the steam turbine by flowing into the casing to increase the flow in the steam path. Often this happens when multiple boilers are used at different pressures, because of their historical existence. These steam turbines are referred to as admission *or* reheat turbines. At steam extraction and admission locations, there are usually steam flow control valves that add to the steam and control system cost.

4.4 Performance Characteristics

Boilers and steam turbines used for large, central station electric power generation can achieve electrical efficiencies of up to 45 percent HHV⁶² though the average efficiency of all units in the field is around 33 percent.⁶³ Backpressure steam turbines used in CHP applications extract only a portion of the steam energy to generate electricity, delivering the rest for process use. Consequently, the electric generation efficiencies for the examples shown are all below 10 percent HHV. However, when the energy value of the steam delivered for process use is considered, the effective electrical efficiency is over 75 percent.

Table 4-2 summarizes performance characteristics for typical commercially available backpressure steam turbines used in CHP applications between 500 kW to 15 MW size range.

Isentropic steam turbine efficiency refers to the ratio of power actually generated from the turbine to what would be generated by a perfect turbine with no internal flowpath losses using steam at the same inlet conditions and discharging to the same downstream pressure. Turbine efficiency is not to be confused with electrical generating efficiency, which is the ratio of net power generated to total fuel input to the cycle. Steam turbine efficiency is a measure of how efficiently the turbine extracts power from the steam itself and is useful in identifying the conditions of the steam as it exhausts from the turbine and in comparing the performance of various steam turbines. Multistage (moderate to high pressure ratio) steam turbines have thermodynamic efficiencies that vary from 65 percent for very small (under 1,000 kW) units to over 90 percent for large industrial and utility sized units. Small, single stage steam turbines can have efficiencies as low as 40 percent.

Heat recovery methods from a steam turbine use back pressure exhaust or extraction steam. However, the term is somewhat misleading, since in the case of steam turbines, it is the steam turbine itself that can be defined as a heat recovery device.

Steam turbine CHP systems are generally characterized by very low power to heat ratios, typically in the 0.05 to 0.2 range. This is because electricity is a byproduct of heat generation, with the system

⁶² All turbine and engine manufacturers quote heat rates in terms of the lower heating value (LHV) of the fuel. However, the usable energy content of fuels is typically measured on a higher heating value basis (HHV). In addition, electric utilities measure power plant heat rates in terms of HHV. For natural gas, the average heat content of natural gas is 1,030 Btu/scf on an HHV basis and 930 Btu/scf on an LHV basis – or about a 10 percent difference.

⁶³ Technology Roadmap: High-Efficiency, Low-Emissions Coal-Fired Power Generation, International Energy Agency, December 4, 2012.

optimized for steam production. Hence, while steam turbine CHP system electrical efficiency⁶⁴ may seem very low, it is because the primary objective is to produce large amounts of steam. The effective electrical efficiency⁶⁵ of steam turbine systems, however, is generally very high, because almost all the energy difference between the high pressure boiler output and the lower pressure turbine output is converted to electricity. This means that total CHP system efficiencies⁶⁶ are generally very high and approach the boiler efficiency level. Steam boiler efficiencies range from 70 to 85 percent HHV depending on boiler type and age, fuel, duty cycle, application, and steam conditions.

Table 4-2. Backpressure Steam Turbine Cost and Performance Characteristics*

Steam Turbine Parameters ⁶⁷	System		
	1	2	3
Nominal Electricity Capacity (kW)	500	3,000	15,000
Typical Application	Industrial, PRV application	Industrial, universities, hospitals	Industrial, universities, hospitals
Equipment Cost (\$/kW) ⁶⁸	\$668	\$401	\$392
Total Installed Cost (\$/kW) ⁶⁹	\$1,136	\$682	\$666
O&M Costs (\$/kW) ⁷⁰	\$0.010	\$0.009	\$0.006
Turbine Isentropic Efficiency (%) ⁷¹	52.5%	61.2%	78.0%
Generator/Gearbox Efficiency (%)	94%	94%	96%
Steam Flow (lbs/hr)	20,050	152,600	494,464
Inlet Pressure (psig)	500	600	700
Inlet Temperature (° Fahrenheit)	550	575	650
Outlet Pressure (psig)	50	150	150
Outlet Temperature (° Fahrenheit)	298	373	379.7
CHP System Parameters	1	2	3
Boiler Efficiency (%), HHV	80%	80%	80%
Electric Efficiency (%), HHV ⁷²	6.27%	4.92%	7.31%
Fuel Input (MMBtu/hr)	27.2	208.3	700.1
Steam to Process (MMBtu/hr)	19.9	155.7	506.8
Steam to Process (kW)	5,844	45,624	148,484
Total CHP Efficiency (%), HHV ⁷³	79.60%	79.68%	79.70%

⁶⁴ Net power output / total fuel input into the system.

⁶⁵ (Steam turbine electric power output) / (Total fuel into boiler – (steam to process/boiler efficiency)).

⁶⁶ Net power and steam generated divided by total fuel input.

⁶⁷ Characteristics for “typical” commercially available steam turbine generator systems provided by Elliott Group.

⁶⁸ Equipment cost includes turbine, gearbox, generator, control system, couplings, oil system (if required), and packaging; boiler and steam system costs are not included.

⁶⁹ Installed costs vary greatly based on site-specific conditions; installed costs of a “typical” simple installation were estimated to be 50-70% of the equipment costs.

⁷⁰ Maintenance assumes normal service intervals over a 5 year period, excludes parts.

⁷¹ The Isentropic efficiency of a turbine is a comparison of the actual power output compared to the ideal, or isentropic, output. It is a measure of the effectiveness of extracting work from the expansion process and is used to determine the outlet conditions of the steam from the turbine.

⁷² CHP electrical efficiency = Net electricity generated/Total fuel into boiler. A measure of the amount of boiler fuel converted into electricity.

Table 4-2. Backpressure Steam Turbine Cost and Performance Characteristics*

Steam Turbine Parameters ⁶⁷	System		
	1	2	3
Power/Heat Ratio ⁷⁴	0.086	0.066	0.101
Net Heat Rate (Btu/kWh) ⁷⁵	4,541	4,540	4,442
Effective Electrical Efficiency (%), HHV	75.15%	75.18%	76.84%
Heat/Fuel Ratio ⁷⁶	0.733	0.748	0.724

* For typical systems available in 2014.

Equipment costs shown include the steam turbine, gearbox, generator, control system, couplings, oil system (if required), and packaging. Installed costs vary greatly based on site-specific conditions. Installed costs of a “typical” simple installation were estimated to be 50-70 percent of the equipment costs. Boiler and steam system costs are not included in these estimates.

4.4.1 Performance Losses

Steam turbines, especially smaller units, may leak steam around blade rows and out the end seals. When the turbine operates or exhausts at a low pressure, as is the case with condensing steam turbines, air can also leak into the system. The leakages cause less power to be produced than expected, and the makeup water has to be treated to avoid boiler and turbine material problems. Air that has leaked needs to be removed, which is usually done by a steam air ejector or a fan removing non-condensable gases from the condenser.

Because of the high pressures used in steam turbines, the casing is quite thick, and consequently steam turbines exhibit large thermal inertia. Large steam turbines must be warmed up and cooled down slowly to minimize the differential expansion between the rotating blades and the stationary parts. Large steam turbines can take over ten hours to warm up. While smaller units have more rapid startup times or can be started from cold conditions, steam turbines differ appreciably from reciprocating engines, which start up rapidly, and from gas turbines, which can start up in a moderate amount of time and load follow with reasonable rapidity.

Steam turbine applications usually operate continuously for extended periods of time, even though the steam fed to the unit and the power delivered may vary (slowly) during such periods of continuous operation. As most steam turbines are selected for applications with high duty factors, the nature of their application often takes care of the need to have only slow temperature changes during operation, and long startup times can be tolerated. Steam boilers similarly may have long startup times, although rapid start-up boilers are available.

⁷³ Total CHP efficiency = (Net electricity generated + Net steam to process)/Total fuel into boiler.

⁷⁴ Power/Heat Ratio = CHP electrical power output (Btu)/useful heat output (Btu).

⁷⁵ Net Heat Rate = (total fuel input to the boiler - the fuel that would be required to generate the steam to process assuming the same boiler efficiency)/steam turbine electric output (kW).

⁷⁶ Effective Electrical Efficiency = (Steam turbine electric power output) / (Total fuel into boiler – (steam to process/boiler efficiency)). Equivalent to 3,412 Btu/kWh/Net Heat Rate.

4.4.2 Performance Enhancements

In industrial steam turbine systems, business conditions determine the requirements and relative values of electric power and process, or steam for heating. Plant system engineers then decide the extent of efficiency enhancing options to incorporate in terms of their incremental effects on performance and plant cost, and select appropriate steam turbine inlet and exhaust conditions. Often the steam turbine is going into a system that already exists and is being modified so that a number of steam system design parameters are already established from previous decisions, which exist as system hardware characteristics and the turbine must be properly matched to these conditions.

As the stack temperature of the boiler exhaust combustion products still contain some heat, tradeoffs are made regarding the extent of investment in heat reclamation equipment for the sake of efficiency improvement. Often the stack exhaust temperature is set at a level where further heat recovery would result in condensation of corrosive chemical species in the stack, with consequential deleterious effects on stack life and safety.

4.4.2.1 Steam Reheat

Higher pressures and temperatures along with steam reheat are used to increase power generation efficiency in large industrial (and utility) systems. The higher the pressure ratio (the ratio of the steam inlet pressure to the steam exit pressure) across the steam turbine, and the higher the steam inlet temperature, the more power it will produce per unit of mass flow, provided that the turbine can reliably accommodate the pressure ratio and that the turbine is not compromised by excessive condensation within the last expansion stage. To avoid condensation within the flowpath or to maximize available steam energy, the inlet steam temperature is increased until the economic life limit of turbine materials is reached. This limit is now generally in the range of 900° F for small industrial steam turbines using typical materials.

Expanding steam can reach a condition of temperature and pressure where condensation to (liquid) water begins. Small amounts of water droplets can be tolerated in the last stages of a steam turbine provided that the droplets are not too large or numerous. Turbine flowpaths can employ features for extracting a portion of the condensate from the flowpath in order to limit water droplet impingement on the blading. Also, protective blade treatments such as Stellite are often employed to harden the blading surfaces exposed to the droplet impingement and reduce blade material erosion. For turbines using a reheat cycle, steam is extracted after it has partially expanded, heated in a heat exchanger, and returned to the turbine flowpath for further expansion.

4.4.2.2 Combustion Air Preheating

In large industrial systems, air preheaters recover heat from the boiler exhaust gas stream, and use it to preheat the combustion air, thereby reducing fuel consumption. Boiler combustion air preheaters are large versions of the heat wheels used for the same purpose on industrial furnaces.

4.4.3 Capital Costs

A steam turbine-based CHP plant is a complex process with many interrelated subsystems that must usually be custom designed. In a steam turbine CHP plant burning a solid biomass fuel, the steam turbine generator makes up only about 10 percent of the total plant equipment costs – the solid fuel

boiler makes up 45 percent and the prep yard, electrostatic precipitator, and other equipment each adding about 15 percent.⁷⁷ Engineering and construction add 70 percent to equipment costs.

The cost of complete solid fuel CHP plants varies with many factors—fuels handling, pollution control equipment and boiler cost are major cost items. Because of both the size of such plants and the diverse sources of the components, solid fuel cogeneration plants invariably involve extensive system engineering and field labor during construction. Typical complete plant costs can be over \$5,000/kW, with little generalization except that for the same fuel and configuration, costs per kW of capacity generally increase as size decreases. While the overall cost of plants with a given steam output would be similar, the amount of steam extracted for process use, and thus not available for power generation, has a significant effect on the costs quoted in \$/kW of electricity out.

Steam turbine costs exhibit a modest extent of irregularity, as steam turbines are made in sizes with finite steps between the sizes. The cost of the turbine is generally the same for the upper and lower limit of the steam flowing through it, so step-like behavior is sometimes seen in steam turbine prices. Since they come in specific size increments, a steam turbine that is used at the upper end of its range of power capability costs less per kW generated than one that is used at the lower end of its capability. Additionally, raw material cost, local labor rates, delivery times, availability of existing major components, and similar business conditions can affect steam turbine pricing.

Often steam turbines are sold to fit into an existing plant. In some of these applications, the specifications, mass flow, pressure, temperature and backpressure or extraction conditions are customized and therefore do not expose themselves to large competition. These somewhat unique machines may be more expensive per kilowatt than other machines that are more generalized, and therefore face greater competition. This is the case for three reasons: 1) a greater amount of custom engineering and manufacturing setup may be required; 2) there is less potential for sales of duplicate or similar units; and 3) there are fewer competitive bidders. The truly competitive products are the “off-the-rack” type machines, while “custom” machines are naturally more expensive.

Because of the relatively high cost of the system, high annual capacity factors are required to enable a reasonable recovery of invested capital.

However, retrofit applications of steam turbines into existing boiler/steam systems can be cost competitive options for a wide variety of users depending on the pressure and temperature of the steam exiting the boiler, the thermal needs of the site, and the condition of the existing boiler and steam system. In such situations, the decision is based only on the added capital cost of the steam turbine, its generator, controls and electrical interconnection, with the balance of plant already in place. Similarly, many facilities that are faced with replacement or upgrades of existing boilers and steam systems often consider the addition of steam turbines, especially if steam requirements are relatively large compared to power needs within the facility.

In general, steam turbine applications are driven by balancing lower cost fuel or avoided disposal costs for the waste fuel, with the high capital cost and (preferably high) annual capacity factor for the steam

⁷⁷ “Cogeneration and Small Power Production Manual,” Scott Spiewak and Larry Weiss, 1997. Data for a 32.3 MW multi-fuel fired, 1,250 psig, 900 °F, 50 psig backpressure steam turbine used in an industrial cogeneration plant.

plant, and the combined energy plant-process plant application through CHP. For these reasons, steam turbines are not normally direct competitors of gas turbines and reciprocating engines.

Steam turbine prices vary greatly with the extent of competition and related manufacturing volumes for units of desired size, inlet and exit steam conditions, rotational speed and standardization of construction. Prices are usually quoted for an assembled steam turbine-electrical generator package. The electrical generator can account for 20 percent to 40 percent of the assembly. As the steam turbine/electrical generator package is heavy, due in large part to the heavy walled construction of the high pressure turbine casing, it must be mounted carefully on an appropriate pedestal or baseplate. The installation and connection to the boiler through high pressure-high temperature steam pipes must be performed with engineering and installation expertise. As the high pressure steam pipes typically vary in temperature by 750° F between cold standby/repair status and full power status, care must be taken in installing a means to accommodate the differential expansion accompanying startup and shutdown to minimize induced stress on the turbine casing. Should the turbine have variable extraction, the cost of the extraction valve and control system adds to the installation.

Small steam turbine generators of less than 1,000 kW are generally more expensive on a per KW basis. However, products have been developed and are being marketed specifically for small market applications.

As the steam for a steam turbine is generated in a boiler by combustion and heat transfer, the temperature of the steam is limited by furnace heat transfer design and manufacturing consideration and boiler tube bundle design. Higher heat fluxes in the boiler enable more compact boilers, with less boiler tube material to be built, however, higher heat fluxes also result in higher boiler tube temperature and the need for the use of a higher grade (adequate strength at higher temperature) boiler tube material. Such engineering economic tradeoffs between temperature (with consequential increases in efficiency) and cost appear throughout the steam plant.

4.4.4 Maintenance

Steam turbines are very rugged units, with operational life often exceeding 50 years. Maintenance is simple, comprised mainly of making sure that all fluids (steam flowing through the turbine and the oil for the bearing) are always clean and at the proper temperature with low levels of moisture or high steam quality or superheat. The oil lubrication system must be clean and at the correct operating temperature and level to maintain proper performance. Other items include inspecting auxiliaries such as lubricating-oil pumps, coolers and oil strainers and checking safety devices such as the operation of overspeed trips.

In order to obtain reliable service, steam turbines require long warm-up periods so that there are minimal thermal expansion stress and wear concerns. Steam turbine maintenance costs are typically below \$0.01/kWh. Boilers and any associated solid fuel processing and handling equipment that is part of the boiler/steam turbine plant require their own types of maintenance which can add \$0.02/kWh for maintenance and \$0.015/kWh for operating labor.

One maintenance issue with steam turbines is that solids can carry over from the boiler and deposit on turbine nozzles and other internal parts, degrading turbine efficiency and power output. Some of these

are water soluble but others are not. Three methods are employed to remove such deposits: 1) manual removal; 2) cracking off deposits by shutting the turbine off and allowing it to cool; and 3) for water soluble deposits, water washing while the turbine is running.

An often-overlooked component in the steam power system is the steam (safety) stop valve, which is immediately ahead of the steam turbine and is designed to be able to experience the full temperature and pressure of the steam supply. This safety valve is necessary because if the generator electric load were lost (an occasional occurrence), the turbine would rapidly overspeed and destroy itself. Other accidents are also possible, supporting the need for the turbine stop valve, which may add significant cost to the system.

4.4.5 Fuels

Industrial boilers operate on a wide variety of fuels, including wood, coal, natural gas, oils (including residual oil, the leftover material when the valuable distillates have been separated for separate sale), municipal solid waste and sludge. The fuel handling, storage and preparation equipment needed for solid fuels considerably adds to the cost of an installation. Thus, such fuels are used only when a high annual capacity factor is expected of the facility, or when the solid material has to be disposed of to avoid an environmental or space occupancy problem.

4.4.6 System Availability

Steam turbines are generally considered to have 99 percent plus availability with longer than one year between shutdowns for maintenance and inspections. This high level of availability applies only to the steam turbine, not to the boiler or HRSG that is supplying the steam. For complete systems, the complexity of the fuel handling, combustion, boiler, and emissions, especially for solid fuels, brings overall availability down below that of reciprocating engines and gas turbines. As shown in **Table 4-3**, a survey of 16 small steam turbine power systems showed an average availability of 90.6 percent with a range of 72.4-99.8 percent. The best system ran for a period of two years without a forced outage.

Table 4-3. Steam Turbine Availability

Other Technologies	Steam Turbines <25MW		
Number Sampled	16		
	Min.	Avg.	Max.
Availability (%)	72.37	90.59	99.82
Forced Outage Rate (%)	0.00	3.12	16.41
Scheduled Outage Factor (%)	0.00	6.88	27.63
Service Factor (%)	3.37	78.72	99.65
Mean Time Between Forced Outages (hrs)	120	828	16,600

Source: ICF⁷⁸

4.5 Emissions and Emissions Control Options

Emissions associated with a steam turbine are dependent on the source of the boiler input fuel. Steam turbines can be used with a boiler firing any one or a combination of a large variety of fuel sources, or

⁷⁸ *Distributed Generation Operational Reliability and Availability Database*, EEA, Inc. (now part of ICF) for ORNL, 2003.

they can be used with a gas turbine in a combined cycle configuration. Boiler emissions vary depending on fuel type and environmental conditions.

Table 4-4 illustrates typical emissions of NO_x, PM, and CO for boilers by size of steam turbine system and by fuel type. SO_x emissions are not based on the size of the boiler; rather, they are a function of the sulfur content of the fuel and the fuel combustion rate. Based on using the average fuel heat content assumptions, uncontrolled input emissions for SO_x range from 0.49-1.9 lbs/MMBtu from coal,⁷⁹ 1.16-2.22 lbs/MMBtu from wood,⁸⁰ 1.53lbs/MMBtu from fuel oils,⁸¹ and very little to insignificant levels from natural gas combustion.

Table 4-4. Typical Boiler Emissions Ranges

Boiler Fuel	System 1 500 kW			Systems 2 and 3 3 MW / 15 MW		
	NO _x	CO	PM	NO _x	CO	PM
Coal (lbs/MMBtu)	N/A	N/A	N/A	0.20-1.24	0.002-0.7	
Wood (lbs/MMBtu)	0.22-0.49	0.6	0.33-0.56	0.22-0.49	0.06	0.33-0.56
Fuel Oil (lbs/MMBtu)	0.15-0.37	0.03	0.01-0.08	0.07-0.31	0.03	0.01-0.08
Natural Gas (lbs/MMBtu)	0.03-0.1	0.08	-	0.1 – 0.28	0.08	-

Note: all emissions values are without post-combustion treatment.

Source: EPA, *Compilation of Air Pollutant Emission Factors, AP-42, Fifth Edition, Volume I: Stationary Point and Area Sources*

4.5.1 Boiler Emissions Control Options - NO_x

NO_x control has been a focus of emission control research and development in boilers. The following provides a description of the most prominent emission control approaches.

4.5.1.1 Combustion Process emissions Control

Combustion control techniques are less costly than post-combustion control methods and are often used on industrial boilers for NO_x control. Control of combustion temperature has been the principal focus of combustion process control in boilers. Combustion control requires tradeoffs – high temperatures favor complete burn up of the fuel and low residual hydrocarbons and CO, but promote NO_x formation. Very lean combustion dilutes the combustion process and reduces combustion temperatures and NO_x formation, and allows a higher compression ratio or peak firing pressures resulting in higher efficiency. However, if the mixture is too lean, misfiring and incomplete combustion occurs, increasing CO and VOC emissions.

⁷⁹ http://www.eia.gov/coal/production/quarterly/co2_article/co2.html

⁸⁰

http://www20.gencat.cat/docs/dmah/Home/Ambits%20dactuacio/Medi%20natural/Gestio%20forestal/Funcions%20dels%20boscos/Funcions%20productores%20del%20bosc/Biomassa%20forestal/Activitats%20realitzades/Curs%20daprofitament%20de%20biomassa%20forestal/2_ncp.pdf

⁸¹ [http://www.imo.org/OurWork/Environment/PollutionPrevention/AirPollution/Pages/Sulphur-oxides-\(SOx\)-%E2%80%93-Regulation-14.aspx](http://www.imo.org/OurWork/Environment/PollutionPrevention/AirPollution/Pages/Sulphur-oxides-(SOx)-%E2%80%93-Regulation-14.aspx)

4.5.1.2 Flue Gas Recirculation (FGR)

FGR is the most effective technique for reducing NO_x emissions from industrial boilers with inputs below 100 MMBtu/hr. With FGR, a portion of the relatively cool boiler exhaust gases re-enter the combustion process, reducing the flame temperature and associated thermal NO_x formation. It is the most popular and effective NO_x reduction method for firetube and watertube boilers, and many applications can rely solely on FGR to meet environmental standards.

External FGR employs a fan to recirculate the flue gases into the flame, with external piping carrying the gases from the stack to the burner. A valve responding to boiler input controls the recirculation rate. Induced FGR relies on the combustion air fan for flue gas recirculation. A portion of the gases travel via ductwork or internally to the air fan, where they are premixed with combustion air and introduced into the flame through the burner. Induced FGR in newer designs utilize an integral design that is relatively uncomplicated and reliable.

The physical limit to NO_x reduction via FGR is 80 percent in natural gas-fired boilers and 25 percent for standard fuel oils.

4.5.1.3 Low Excess Air Firing (LAE)

Boilers are fired with excess air to ensure complete combustion. However, excess air levels greater than 45 percent can result in increased NO_x formation, because the excess nitrogen and oxygen in the combustion air entering the flame combine to form thermal NO_x. Firing with low excess air means limiting the amount of excess air that enters the combustion process, thus limiting the amount of extra nitrogen and oxygen entering the flame. This is accomplished through burner design modification and is optimized through the use of oxygen trim controls.

LAE typically results in overall NO_x reductions of 5 to 10 percent when firing with natural gas, and is suitable for most boilers.

4.5.1.4 Low Nitrogen Fuel Oil

NO_x formed by fuel-bound nitrogen can account for 20 to 50 percent of total NO_x levels in oil-fired boiler emissions. The use of low nitrogen fuels in boilers firing distillate oils is one method of reducing NO_x emissions. Such fuels can contain up to 20 times less fuel-bound nitrogen than standard No. 2 oil.

NO_x reductions of up to 70 percent over NO_x emissions from standard No. 2 oils have been achieved in firetube boilers utilizing flue gas recirculation.

4.5.1.5 Burner Modifications

By modifying the design of standard burners to create a larger flame, lower flame temperatures and lower thermal NO_x formation can be achieved, resulting in lower overall NO_x emissions. While most boiler types and sizes can accommodate burner modifications, it is most effective for boilers firing natural gas and distillate fuel oils, with little effectiveness in heavy oil-fired boilers. Also, burner modifications must be complemented with other NO_x reduction methods, such as flue gas recirculation, to comply with the more stringent environmental regulations. Achieving low NO_x levels (30 ppm) through burner modification alone can adversely impact boiler operating parameters such as turndown, capacity, CO levels, and efficiency.

4.5.1.6 Water/Steam Injection

Injecting water or steam into the flame reduces flame temperature, lowering thermal NO_x formation and overall NO_x emissions. However, under normal operating conditions, water/steam injection can lower boiler efficiency by 3 to 10 percent. Also, there is a practical limit to the amount that can be injected without causing condensation-related problems. This method is often employed in conjunction with other NO_x control techniques such as burner modifications or flue gas recirculation.

When used with natural gas-fired boilers, water/steam injection can result in NO_x reduction of up to 80 percent, with lower reductions achievable in oil-fired boilers.

4.5.2 Post-Combustion Emissions Control

There are several types of exhaust gas treatment processes that are applicable to industrial boilers.

4.5.2.1 Selective Non-Catalytic Reduction (SNCR)

In a boiler with SNCR, a NO_x reducing agent such as ammonia or urea is injected into the boiler exhaust gases at a temperature in the 1,400 to 1,600° F range. The agent breaks down the NO_x in the exhaust gases into water and atmospheric nitrogen (N₂). While SNCR can reduce boiler NO_x emissions by up to 70 percent, it is very difficult to apply this technology to industrial boilers that modulate or cycle frequently because the agent must be introduced at a specific flue gas temperature in order to perform properly. Also, the location of the exhaust gases at the necessary temperature is constantly changing in a cycling boiler.

4.5.2.2 Selective Catalytic Reduction (SCR)

This technology involves the injection of the reducing agent into the boiler exhaust gas in the presence of a catalyst. The catalyst allows the reducing agent to operate at lower exhaust temperatures than SNCR, in the 500 to 1,200° F depending on the type of catalyst. NO_x reductions of up to 90 percent are achievable with SCR. The two agents used commercially are ammonia (NH₃ in anhydrous liquid form or aqueous solution) and aqueous urea. Urea decomposes in the hot exhaust gas and SCR reactor, releasing ammonia. Approximately 0.9 to 1.0 moles of ammonia is required per mole of NO_x at the SCR reactor inlet in order to achieve an 80 to 90 percent NO_x reduction.

SCR is however costly to use and can only occasionally be justified on boilers with inputs of less than 100 MMBtu/hr. SCR requires on-site storage of ammonia, a hazardous chemical. In addition, ammonia can “slip” through the process unreacted, contributing to environmental and health concerns.

4.5.2.3 Boiler Emissions Control Options – SO_x

The traditional method for controlling SO_x emissions is dispersion via a tall stack to limit ground level emissions. The more stringent SO_x emissions requirements in force today demand the use of reduction methods as well. These include use of low sulfur fuel, desulfurizing fuel, and flue gas desulfurization (FGD). Desulfurization of fuel, such as in FGD, primarily applies to coal, and is principally used for utility boiler emissions control. Use of low sulfur fuels is the most cost effective SO_x control method for industrial boilers, as it does not require installation and maintenance of special equipment.

FGD systems are of two types: non-regenerable and regenerable. The most common non-regenerable results in a waste product that requires proper disposal. Regenerable FGD converts the waste product into a product that is saleable, such as sulfur or sulfuric acid. SO_x emissions reductions of up to 95 percent can be obtained with FGD.

4.6 Future Developments

While steam turbines are a mature technology, their importance in worldwide power generation makes incremental improvements in cost and performance very beneficial. Higher efficiencies reduce fuel consumption, emissions of air pollutants and greenhouse gases, and cooling water requirements. Since commercial introduction, efficiencies for large condensing steam turbines have increased from the mid-teens to up to 48 percent. The U.S. Department of Energy funds collaborative research and development toward the development of improved ultra-supercritical (USC) steam turbines capable of efficiencies of 55-60 percent that are based on boiler tube materials that can withstand pressures of up to 5,000 psi and temperatures of 1,400° F. To achieve these goals, work is ongoing in materials, internal design and construction, steam valve development, and design of high pressure casings. A prototype is targeted for commercial testing by 2025.⁸²

Research is also underway to restore and improve the performance of existing steam turbines in the field through such measures as improved combustion systems for boilers, heat transfer and aerodynamics to improve turbine blade life and performance, and improved materials to permit longer life and higher operating temperatures for more efficient systems.⁸³

The focus on renewable markets, such as waste heat recovery, biomass fueled power, and CHP plants, is stimulating the demand for small and medium steam turbines. Technology and product development for these markets should bring about future improvements in steam turbine efficiency, longevity, and cost. This could be particularly true for systems below 500 kW that are used in developmental small biomass systems, and in waste-heat-to-power systems, as the latter is designed to operate in place of pressure reduction valves in commercial and industrial steam systems operating at multiple pressures.

⁸² Advanced Turbines Technology Program Plan, National Energy Technology Laboratory, Clean Coal Research Program, U.S. Department of Energy, January 2013.

⁸³ Energy Tech, <http://www.energy-tech.com/article.cfm?id=17566>

Section 5. Technology Characterization – Microturbines

5.1 Introduction

Microturbines, as the name implies, are small combustion turbines that burn gaseous or liquid fuels to drive an electrical generator, and have been commercially available for more than a decade. Today's microturbine technology is the result of development work in small stationary and automotive gas turbines, auxiliary power equipment, and turbochargers, much of which took place in the automotive industry beginning in the 1950s. The development of microturbine systems was accelerated by the similarity of design to large engine turbochargers, and that provided the basis for the engineering and manufacturing technology of microturbine components.

During the 1990s several companies developed competing microturbine products and entered, or planned to enter, the market. As the market matured, the industry underwent a consolidation phase during which companies merged, changed hands, or dropped out of the market. In the United States today, this has led to two main manufacturers of stationary microturbine products – Capstone Turbine Corporation and FlexEnergy.

Table 5-1 provides a summary of microturbine attributes. Microturbines range in size from 30 to 330 kilowatts (kW). Integrated packages consisting of multiple microturbine generators are available up to 1,000 kW, and such multiple units are commonly installed at sites to achieve larger power outputs. Microturbines are able to operate on a variety of fuels, including natural gas, sour gas (high sulfur, low Btu content), and liquid petroleum fuels (e.g., gasoline, kerosene, diesel fuel, and heating oil).

Table 5-1. Summary of Microturbine Attributes

Electrical Output	Available from 30 to 330 kW with integrated modular packages up to 1,000 kW.
Thermal Output	Exhaust temperatures in the range of 500 to 600 °F, suitable for supplying a variety of site thermal needs, including hot water, steam, and chilled water (using an absorption chiller).
Fuel Flexibility	Can utilize a number of different fuels, including natural gas, sour gas (high sulfur, low Btu content), and liquid fuels (e.g., gasoline, kerosene, diesel fuel, and heating oil).
Reliability and life	Design life is estimated to be 40,000 to 80,000 hours with overhaul.
Emissions	Low NO _x combustion when operating on natural gas; capable of meeting stringent California standards with carbon monoxide/volatile organic compound (CO/VOC) oxidation catalyst.
Modularity	Units may be connected in parallel to serve larger loads and to provide power reliability.
Part-load Operation	Units can be operated to follow load with some efficiency penalties.
Dimensions	Compact and light weight, 2.3-2.7 cubic feet (cf) and 40-50 pounds per kW.

5.2 Applications

Microturbines are ideally suited for distributed generation applications due to their flexibility in connection methods, their ability to be stacked in parallel to serve larger loads, their ability to provide

stable and reliable power, and their low emissions compared to reciprocating engines. Important applications and functions are described below:

- **Combined heat and power (CHP)** – microturbines are well suited to be used in CHP applications because the exhaust heat can either be recovered in a heat recovery boiler, or the hot exhaust gases can be used directly. Typical natural gas fueled CHP markets include:
 - Commercial – hotels, nursing homes, health clubs
 - Institutional – public buildings
 - Industrial – small operations needing hot water or low pressure steam for wash water as in the food and manufacturing sectors
- **Combined cooling heating and power (CCHP)** – The temperature available for microturbine exhaust allows effective use with absorption cooling equipment that is driven either by low pressure steam or by the exhaust heat directly. Cooling can be added to CHP in a variety of commercial/institutional applications to provide both cooling and heating.
- **Resource recovery** – the ability of microturbines to burn a variety of fuels make it useful for resource recovery applications including landfill gas, digester gas, oil and gas field pumping and power applications, and coal mine methane use.
- **Peak shaving and base load power** (grid parallel).
- **Thermal oxidation of very low Btu fuel or waste streams** – Microturbine systems have been designed to provide thermal oxidation for applications needing methane or volatile organic compound destruction such as for landfill gas or other waste gases.
- **Premium power and power quality** – due to the inverter based generators, power quality functionality can be added to CHP, and power-only applications allowing the system to be part of an overall uninterruptible power supply (UPS) system providing black start capability and back-up power capability to provide power when the electrical grid is down. The system can also provide voltage and other power quality support. Such functions are useful for applications with high outage costs and sensitive power needs including small data centers, hospitals, nursing homes, and a variety of other applications that have critical service requirements.
- **Power only applications** – microturbines can be used for stand-alone power in remote applications where grid power is either unavailable or very high cost. The systems can also run as back-up power or in peak-shaving mode, though such use is limited.
- **Microgrid** – Microturbines are inverter based generation, and are therefore well-suited for application in utility microgrids, providing grid support and grid communication functions. This area of use is in a development and demonstration phase by electric power companies.

5.3 Technology Description

5.3.1 Basic Process

Microturbines operate on the same thermodynamic cycle (Brayton Cycle) as larger gas turbines and share many of the same basic components. In this cycle, atmospheric air is compressed, heated (usually

by introducing and burning fuel), and then these hot gases drive an expansion turbine that drives both the inlet compressor and a drive shaft capable of providing mechanical or electrical power. Other than the size difference, microturbines differ from larger gas turbines in that they typically have lower compression ratios and operate at lower combustion temperatures. In order to increase efficiency, microturbines recover a portion of the exhaust heat in a heat exchanger called a recuperator, to increase the energy of the gases entering the expansion turbine thereby boosting efficiency. Microturbines operate at high rotational speeds of up to 60,000 revolutions per minute. Of the two primary players in the domestic industry, Capstone couples this shaft output directly to a high speed generator and uses power electronics to produce 60 Hz electricity. FlexEnergy uses a gearbox to reduce the drive speed to 3600 rpm to power a synchronous electric generator.

5.3.2 Components

Figure 5-1 shows a schematic diagram of the basic microturbine components, which include the combined compressor/turbine unit, generator, recuperator, combustor, and CHP heat exchanger. Each of these primary components is described further below.

Figure 5-1. Microturbine-based CHP System Schematic

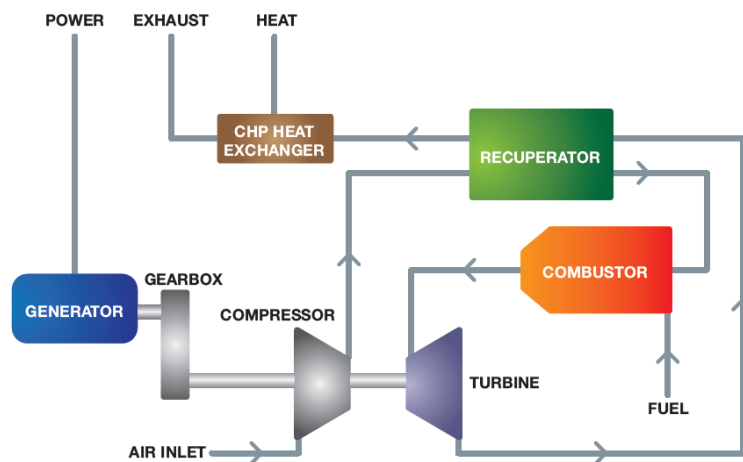

Source: FlexEnergy

5.3.2.1 Turbine & Compressor

The heart of the microturbine is the compressor-turbine package (or turbocompressor), which is commonly mounted on a single shaft along with the electric generator. The shaft, rotating at upwards of 60,000 rpm, is supported on either air bearings or conventional lubricated bearings. The single moving part of the one-shaft design has the potential for reducing maintenance needs and enhancing overall reliability.

Microturbine turbomachinery is based on single-stage radial flow compressors and turbines, unlike larger turbines that use multi-stage axial flow designs. Radial design turbomachinery handles the small volumetric flows of air and combustion products with reasonably high component efficiency.⁸⁴ Large-

¹ With axial flow turbomachinery, blade height would be too small to be practical.

size axial flow turbines and compressors are typically more efficient than radial flow components. However, in the size range for microturbines – 0.5 to 5 lbs/second of air/gas flow – radial flow components offer minimum surface and end wall losses thereby improving efficiency.

As mentioned earlier, microturbines operate on either oil-lubricated or air bearings, which support the shaft. *Oil-lubricated bearings* are mechanical bearings and come in three main forms – high-speed metal roller, floating sleeve, and ceramic surface. Ceramic surface bearings typically offer the most attractive benefits in terms of life, operating temperature, and lubricant flow. While they are a well-established technology, they require an oil pump, oil filtering system, and liquid cooling that add to microturbine cost and maintenance. In addition, the exhaust from machines featuring oil-lubricated bearings may not be useable for direct space heating in cogeneration configurations due to the potential for air contamination.

Air bearings allow the turbine to spin on a thin layer of air, so friction is low and rpm is high. They have been in service on airplane cabin cooling systems for many years. No oil or oil pump is needed. Air bearings offer simplicity of operation without the cost, reliability concerns, maintenance requirements, or power drain of an oil supply and filtering system.

5.3.2.2 Generator

The microturbine produces electrical power either via a high-speed generator turning on the single turbo-compressor shaft or through a speed reduction gearbox driving a conventional 3,600 rpm generator. The high-speed generator single-shaft design employs a permanent magnet, and an air-cooled generator producing variable voltage and high-frequency AC power. This high frequency AC output (about 1,600 Hz for a 30 kW machine) is converted to constant 60 Hz power output in a power conditioning unit. Power conditioning involves rectifying the high frequency AC to DC, and then inverting the DC to 60 Hz AC. However, power conversion comes with an efficiency penalty (approximately 5 percent). In addition to the digital power controllers converting the high frequency AC power into usable electricity, they also filter to reduce harmonic distortion in the output. The power conditioning unit is a critical component in the single-shaft microturbine design and represents significant design challenges, specifically in matching turbine output to the required load. To accommodate transients and voltage spikes, power electronic units are generally designed to handle seven times the nominal voltage. Most microturbine power electronics generate three-phase electricity.

To start-up a single shaft design, the generator acts as a motor turning the turbo-compressor shaft until sufficient rpm is reached to start the combustor. If the system is operating independent of the grid (black starting), a power storage unit (typically a battery) is used to power the generator for start-up.

Electronic components also direct all of the operating and startup functions. Microturbines are generally equipped with controls that allow the unit to be operated in parallel or independent of the grid, and internally incorporate many of the grid and system protection features required for interconnection. The controls also allow for remote monitoring and operation.

Figure 5-2 provides an example of the compact design of the basic microturbine components (in this case, for the Capstone model C200 (200 kW)). The turbocompressor section, riding on air bearings,

drives the high speed, air cooled generator. The entire assembly is surrounded by a can-like structure housing the recuperator and the combustion chamber.

Figure 5-2. Compact Microturbine Design

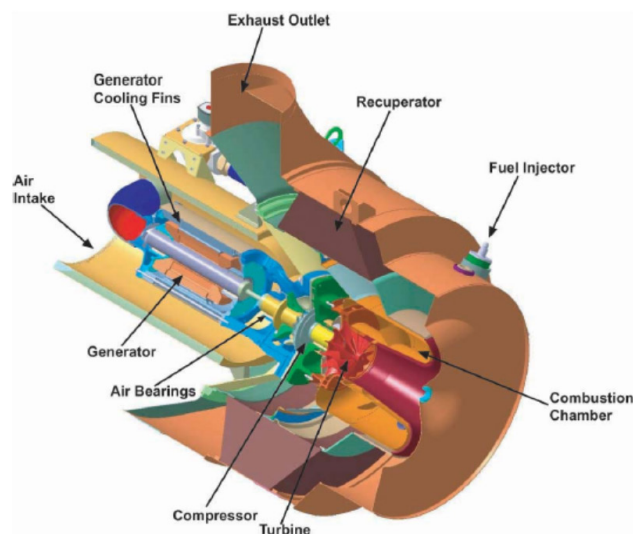

Source: Capstone Turbines, C200

5.3.2.3 Recuperator & Combustor

The recuperator is a heat exchanger that uses the hot turbine exhaust gas (typically around 1,200°F) to preheat the compressed air (typically around 300°F) going into the combustor, thereby reducing the fuel needed to heat the compressed air to the required turbine inlet temperature. Depending on microturbine operating parameters, recuperators can more than double machine efficiency. However, since there is increased pressure drop on both the compressed air and turbine exhaust sides of the recuperator, this increased efficiency comes at the expense of about a 10-15 percent drop in power output.

5.3.2.4 CHP Heat Exchanger

In CHP operation, microturbines offer an additional heat exchanger package, integrated with the basic system, that extracts much of the remaining energy in the turbine exhaust, which exits the recuperator at about 500-600° F. Exhaust heat can be used for a number of different applications, including potable water heating, space heating, thermally activated cooling and dehumidification systems (absorption chillers, desiccant dehumidification). Because microturbine exhaust is clean and has a high percentage (15 percent) of oxygen, it can also be used directly for process applications such as driving a double-effect absorption chiller or providing preheat combustion air for a boiler or process heat application.

5.4 Performance Characteristics

Table 5-2 summarizes cost and performance characteristics for typical microturbine CHP systems ranging in size from 30 kW to 1 MW. Heat rates and efficiencies are based on manufacturers' specifications for systems operating on natural gas, the predominant fuel choice in CHP applications. The table assumes that natural gas is delivered at typical low delivery pressures which require a booster

compressor to raise the gas pressure to the point at which it can be introduced into the compressed inlet air-stream. Electrical efficiencies and heat rates shown are net of power losses from the gas booster compressor. Customers that have, or can gain access to, high pressure gas from their local gas utility can avoid the capacity and efficiency losses due to fuel gas compression. Capital costs, described in more detail in a later section, are based on assumptions of a basic grid connect installation. Installation costs can vary widely depending on site conditions and regional differences in material, labor, and site costs. Available thermal energy is calculated based on manufacturer specifications on turbine exhaust flows and temperatures. CHP thermal recovery estimates are based on producing hot water for process or space heating applications. All performance specifications are at full load International Organization for Standards (ISO) conditions (59 °F, 60 percent RH, 14.7 psia).

The data in the table show that electrical efficiency generally increases as the microturbine becomes larger. Microturbines have lower electrical efficiencies than reciprocating engines and fuel cells, but are capable of high overall CHP efficiencies. The low power to heat ratios (P/H) of microturbines (which implies relatively more heat production), makes it important for both overall efficiency and for economics to be sited and sized for applications that allow full utilization of the available thermal energy.

As shown, microturbines typically require 50 to 140 psig fuel supply pressure. Local distribution gas pressures usually range from 30 to 130 psig in feeder lines and from 1 to 50 psig in final distribution lines. If available, sites that install microturbines will generally opt for high pressure gas delivery rather than adding the cost of a booster compressor with its accompanying efficiency and capacity losses.

Estimated installed capital costs range from \$4,300/kW for the 30 kW system down to \$2,500/kW for the 1,000 kW system – described in more detail in Section *Capital Cost*.

Table 5-2. Microturbine Cost and Performance Characteristics

Microturbine Characteristics [1]	System					
	1	2	3	4	5	6
Nominal Electricity Capacity (kW)	30	65	200	250	333	1000
Compressor Parasitic Power (kW)	2	4	10	10	13	50
Net Electricity Capacity (kW)	28	61	190	240	320	950
Fuel Input (MMBtu/hr), HHV	0.434	0.876	2.431	3.139	3.894	12.155
Required Fuel Gas Pressure (psig)	55-60	75-80	75-80	80-140	90-140	75-80
Electric Heat Rate (Btu/kWh), LHV [2]	13,995	12,966	11,553	11,809	10,987	11,553
Electric Efficiency (%), LHV [3]	24.4%	26.3%	29.5%	28.9%	31.1%	29.5%
Electric Heat Rate (Btu/kWh), HHV	15,535	14,393	12,824	13,110	12,198	12,824
Electric Efficiency (%), HHV	21.9%	23.7%	26.6%	26.0%	28.0%	26.6%
CHP Characteristics						
Exhaust Flow (lbs/sec)	0.68	1.13	2.93	4.7	5.3	14.7
Exhaust Temp (°F)	530	592	535	493	512	535
Heat Exchanger Exhaust Temp (°F)	190	190	200	190	190	200
Heat Output (MMBtu/hr)	0.21	0.41	0.88	1.28	1.54	4.43

Table 5-2. Microturbine Cost and Performance Characteristics

Microturbine Characteristics [1]	System					
	1	2	3	4	5	6
Heat Output (kW equivalent)	61.0	119.8	258.9	375.6	450.2	1,299.0
Total CHP Efficiency (%), HHV [4]	70.0%	70.4%	63.0%	66.9%	67.5%	63.1%
Total CHP Efficiency (%), LHV	77.3%	77.8%	69.6%	73.9%	74.6%	69.8%
Power/Heat Ratio [5]	0.46	0.51	0.73	0.64	0.71	0.73
Net Heat Rate (Btu/kWh) [6]	6,211	5,983	6,983	6,405	6,170	6,963
Effective Electric Eff. (%), HHV [7]	54.9%	57.0%	48.9%	53.3%	55.3%	49.0%
Cost						
CHP Package Cost (\$/kW) [8]	\$2,690	\$2,120	\$2,120	\$1,840	\$1,770	\$1,710
Total Installed Cost (\$/kW) [9]	\$4,300	\$3,220	\$3,150	\$2,720	\$2,580	\$2,500

Notes:

1. Characteristics presented are representative of commercially available microturbine systems. Table data are based from smallest to largest: Capstone C30,; Capstone C65 CARB, Capstone C200 CARB, FlexEnergy MT250, FlexEnergy MT330, Capstone C1000-LE
2. Turbine and engine manufacturers quote heat rates in terms of the lower heating value (LHV) of the fuel. Gas utilities typically report the energy content on a higher heating value (HHV) basis. In addition, electric utilities measure power plant heat rates in terms of HHV. For natural gas, the average heat content is near 1,030 Btu/scf on an HHV basis and about 930 Btu/scf on an LHV basis – a ratio of approximately 0.9 (LHV / HHV).
3. Electrical efficiencies are net of parasitic and conversion losses. Fuel gas compressor needs based on 1 psi inlet supply.
4. Total Efficiency = (net electricity generated + net heat produced for thermal needs)/total system fuel input
5. Power/Heat Ratio = CHP electrical power output (Btu)/ useful heat output (Btu)
6. Net Heat Rate = (total fuel input to the CHP system - the fuel that would be normally used to generate the same amount of thermal output as the CHP system output assuming an efficiency of 80 percent)/CHP electric output (kW).
7. Effective Electrical Efficiency = (CHP electric power output) / (total fuel into CHP system – total heat recovered/0.8).
8. Equipment cost only. The cost for all units, except the 30 kW size, includes integral heat recovery water heater. All units include a fuel gas booster compressor.
9. Installed costs based on CHP system producing hot water from exhaust heat recovery in a basic installation in grid connect mode.

5.4.1 Part-Load Performance

Microturbines that are in applications that require electric load following must operate during some periods at part load. Although, operationally, most installations are designed to operate at a constant output without load-following or frequent starts and stops. Multiple unit installations can achieve load following through sequentially turning on more units requiring less need for part load operation. When less than full electrical power is required from a microturbine, the output is reduced by a combination of mass flow reduction (achieved by decreasing the compressor speed) and turbine inlet temperature reduction. In addition to reducing power, this change in operating conditions also reduces efficiency. **Figure 5-3** shows a sample part-load efficiency curve for the Capstone C65. At 50 percent power output, the electrical efficiency drops by about 15 percent (decline from approximately 30 percent to 25 percent). However, at 50 percent power output, the thermal output of the unit only drops 41 percent resulting in a net loss of CHP efficiency of only 5 percent.

Figure 5-3. Part Load Efficiency at ISO Conditions, Capstone C65

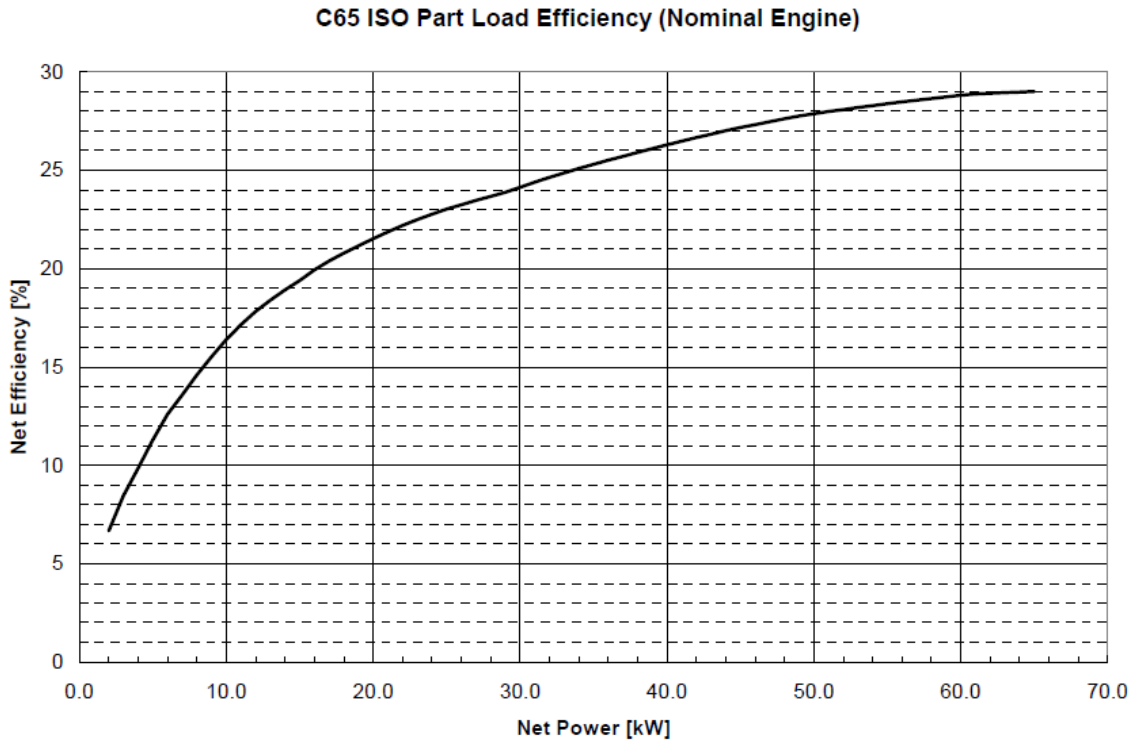

Source: Capstone, C65 Technical Reference

5.4.2 Effects of Ambient Conditions on Performance

The ambient conditions (temperature and air pressure) under which a microturbine operates have a noticeable effect on both the power output and efficiency. This section provides a better understanding of the changes observed due to changes in temperature and air pressure. At elevated inlet air temperatures, both the power and efficiency decrease. The power decreases due to the decreased mass flow rate of air (since the density of air declines as temperature increases), and the efficiency decreases because the compressor requires more power to compress air that is less dense. Conversely, the power and efficiency increase with reduced inlet air temperature.

Figure 5-5 shows the variation in power and efficiency for a microturbine as a function of ambient temperature compared to the reference International Organization for Standards (ISO) condition of sea level and 59°F. The density of air decreases at altitudes above sea level. Consequently, power output decreases. **Figure 5-4** shows the effect of temperature on output, and **Figure 5-5** shows the effect on efficiency for the Capstone C200. The Capstone unit maintains a steady output up to 70-80 °F due to a limit on the generator output. However, the efficiency declines more uniformly as ambient temperature increases. **Figure 5-6** shows a combined power and efficiency curve for the FlexEnergy MT250. For this model, both power output and efficiency change more or less uniformly above and below the ISO rating point.

Figure 5-4. Temperature Effect on Power, Capstone C200-LP

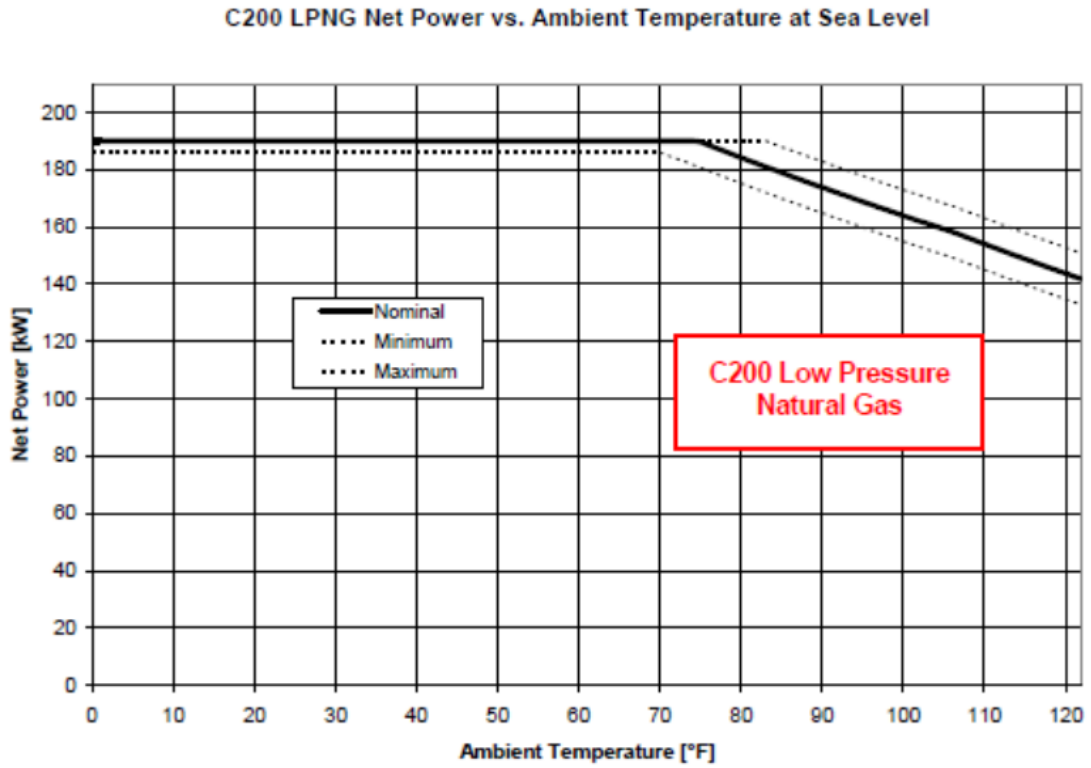

Source: Capstone Turbines

Figure 5-5. Temperature Effect on Efficiency, Capstone C200-LP

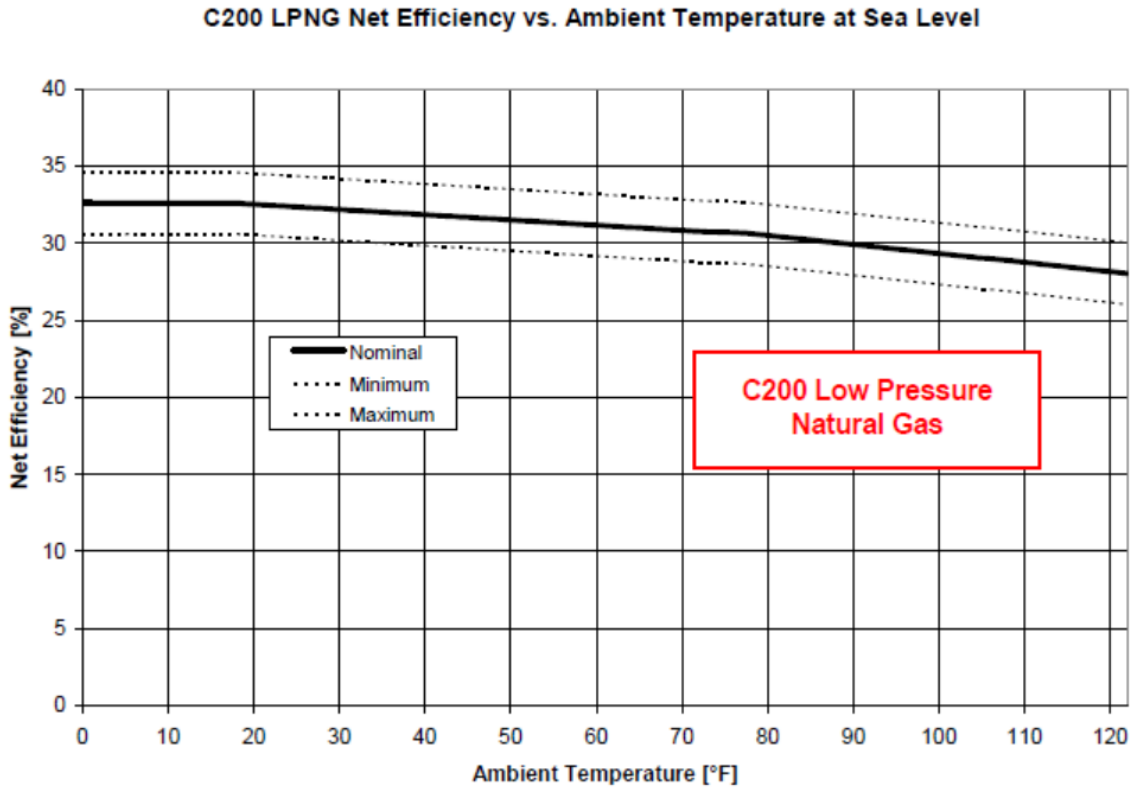

Source: Capstone Turbines

Figure 5-6. Temperature Effect on Power and Efficiency, FlexEnergy MT250

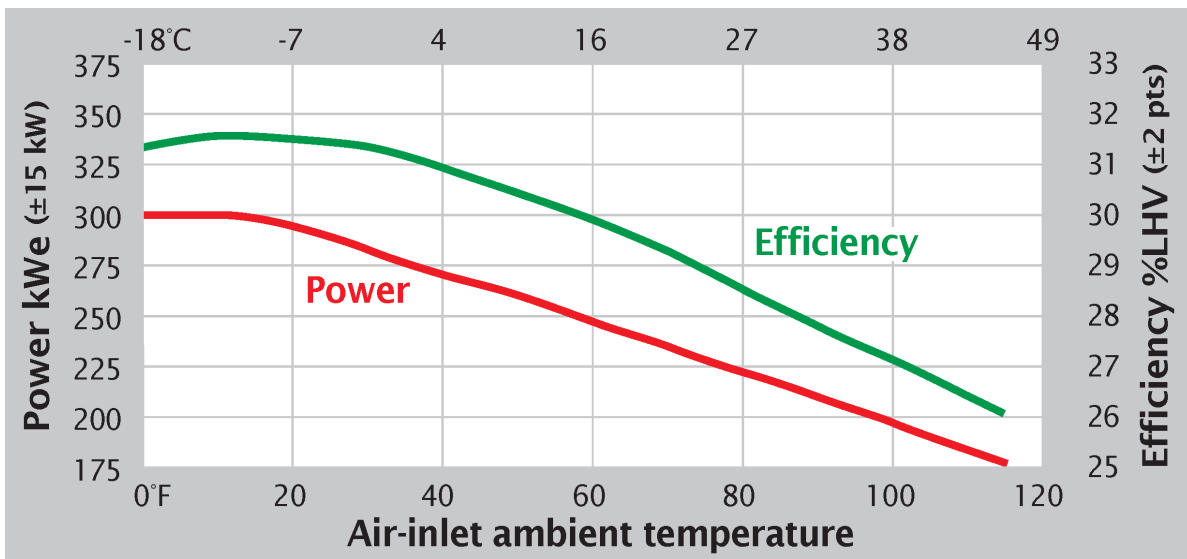

Source: FlexEnergy

Inlet air cooling can mitigate the decreased power and efficiency resulting from high ambient air temperatures. While inlet air cooling is not a feature on today's microturbines, cooling techniques now entering the market, or being employed, on large gas turbines may work their way into next generation microturbine products.

Evaporative cooling, a relatively low capital cost technique, is the most likely inlet air cooling technology to be applied to microturbines. It uses a very fine spray of water directly into the inlet air stream. Evaporation of the water reduces the temperature of the air. Since cooling is limited to the wet bulb air temperature, evaporative cooling is most effective when the wet bulb temperature is significantly below the dry bulb temperature. In most locales with high daytime dry bulb temperatures, the wet bulb temperature is often 20°F lower. This temperature difference affords an opportunity for substantial evaporative cooling. However, evaporative cooling can consume large quantities of water, making it difficult to operate in arid climates.

Refrigeration cooling in microturbines is also technically feasible. In refrigeration cooling, a compression-driven or thermally activated (absorption) refrigeration cycle cools the inlet air through a heat exchanger. The heat exchanger in the inlet air stream causes an additional pressure drop in the air entering the compressor, thereby slightly lowering cycle power and efficiency. However, as the inlet air is now substantially cooler than the ambient air, there is a significant net gain in power and efficiency. Electric motor driven refrigeration results in a substantial amount of parasitic power loss. Thermally activated absorption cooling can use waste heat from the microturbine, reducing the direct parasitic loss. The relative complexity and cost of these approaches, in comparison with evaporative cooling, render them less likely.

Finally, it is also technically feasible to use thermal energy storage systems – typically ice, chilled water, or low-temperature fluids – to cool inlet air. These systems eliminate most parasitic losses from the augmented power capacity. Thermal energy storage is a viable option if on-peak power pricing only occurs a few hours a day. In that case, the shorter time of energy storage discharge and longer time for daily charging allow for a smaller and less expensive thermal energy storage system.

The density of air also decreases with increasing altitude. The effect of altitude derating on the Capstone C65 is shown in **Figure 5-7**. An installation in the mile high city of Denver would have a capacity of only 56 kW – a 14 percent drop in capacity. Unlike the effects of temperature rise, an increase in altitude at a given temperature does not have much impact on energy efficiency. The units operate at nearly the same efficiency, though at a lower output.

Figure 5-7. Ambient Elevation vs. Temperature Derating, Capstone C65

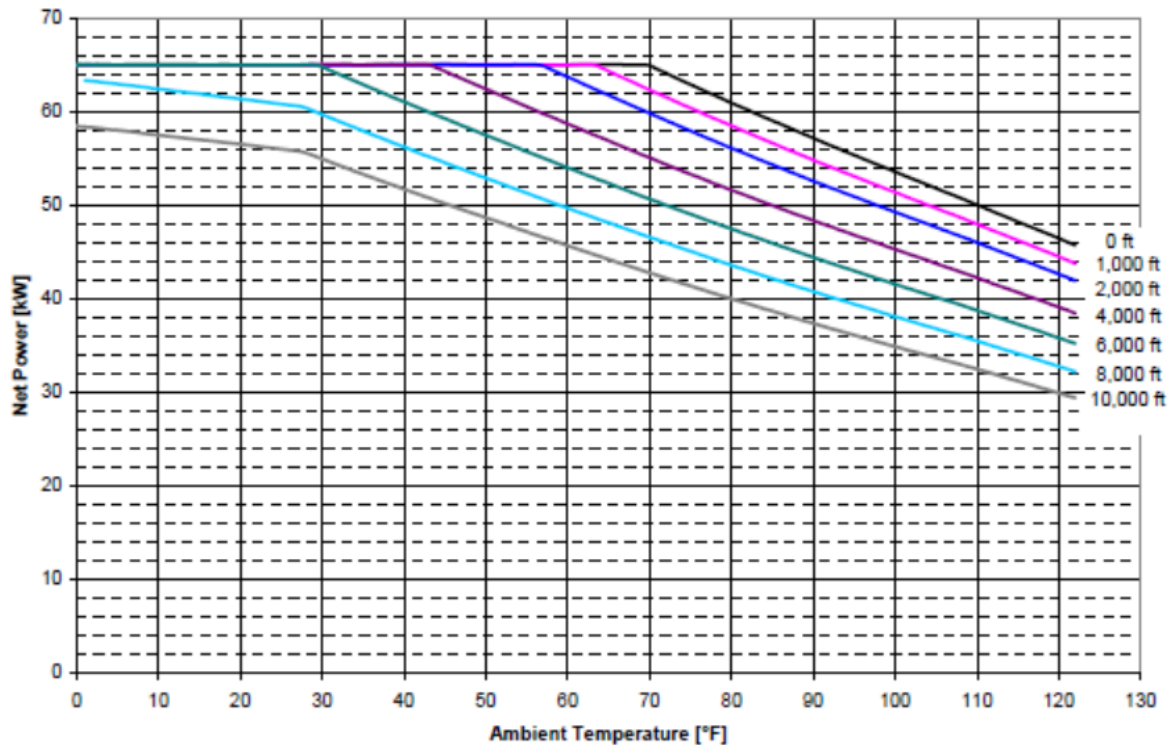

Source: Capstone Turbines

Gas turbine and microturbine performance is also affected by inlet and exhaust back-pressure. ISO ratings are at zero inlet pressure with no exhaust back-pressure. Adding the additional CHP heat exchanger definitely produces some increase in exhaust back pressure. Pressure drops on the inlet side from air filters also reduces the system output and efficiency. For the C65 shown in the previous figure, every 1" pressure drop on the inlet side produces roughly a 0.6 percent drop in power and a 0.2 percent drop in efficiency. A 1" pressure drop on the exhaust side produces about a 0.35 percent drop in power and a 0.25 percent drop in efficiency.

It is important when evaluating microturbine performance at a given site to consider all of the derating factors that are relevant: site altitude, average temperature and seasonal temperature swings, and pressure loss derating resulting from filters and the CHP heat recovery system. The combination of these factors can have a significant impact on both capacity and efficiency. Reduction in capacity also impacts the unit costs of the equipment because the same costs are being spread over fewer kilowatts.

5.4.3 Capital Cost

This section provides study estimates of capital costs for basic microturbine CHP installations. It is assumed that the thermal energy extracted from the microturbine exhaust is used for producing hot water for use on-site. Equipment-only and installed costs are estimated for each representative microturbine system. It should be emphasized that installed costs can vary significantly depending on the scope of the plant equipment, geographical area, competitive market conditions, special site

requirements, emissions control requirements, prevailing labor rates, and whether the system is a new or a retrofit application.

Table 5-3 provides cost estimates for combined heat and power applications, assuming that the CHP system produces hot water and that there is no fuel pretreatment. Thermal recovery in the form of cooling can be accomplished with the addition of an absorption chiller – not included in this comparison. The basic microturbine package consists of the microturbine and power electronics. All of the commercial and near-commercial units offer basic interconnection and paralleling functionality as part of the package cost. All but one of the systems offers an integrated heat exchanger heat recovery system for CHP within the package.

There is little additional equipment that is required for these integrated systems. A heat recovery system has been added where needed, and additional controls and remote monitoring equipment have been added. The total plant cost consists of total equipment cost plus installation labor and materials (including site work), engineering, project management (including licensing, insurance, commissioning and startup), and financial carrying costs during a typical 3-month construction period.

The basic equipment costs represent material on the loading dock, ready to ship. It includes the cost of the generator package, the heat recovery, the flue gas compression and interconnection equipment cost. As shown in the table, the cost to a customer for installing a microturbine-based CHP system includes a number of other factors that increase the total costs by 70-80 percent.

Labor/materials represent the labor cost for the civil, mechanical, and electrical work and materials such as ductwork, piping, and wiring. A number of other costs are also incurred. These costs are often referred to as *soft costs* and they vary widely by installation, by development channel and by approach to project management. Engineering costs are required to design the system and integrate it functionally with the application’s electrical and mechanical systems. In this characterization, environmental permitting fees are included. Project and construction management also includes general contractor markup, and bonding and performance guarantees. Contingency is assumed to be 5 percent of the total equipment cost in all cases. An estimated financial interest of 5 percent during a 3-month construction period is also included.

The cost estimates shown represent a basic installation. In the California Self-Generation incentive Program (SGIP) the average installation cost for 116 non-renewable fuel microturbine systems between 2001-2008 was \$3,150/kW. For 26 renewable fueled systems over the same time period, the average installed cost was \$3,970/kW.⁸⁵

Table 5-3. Equipment and Installation Costs

	System					
	1	2	3	4	5	6
Electric Capacity						
Nominal Capacity (kW)	30	65	200	250	333	1000
Net Capacity (kW)	28	61	190	240	320	950

⁸⁵ CPUC Self-Generation Incentive Program: Cost Effectiveness of Distributed Generation Technologies, ITRON, Inc., 2011.

Table 5-3. Equipment and Installation Costs

	System					
	1	2	3	4	5	6
Equipment Costs						
Gen Set Package	\$53,100	\$112,900	\$359,300	\$441,200	\$566,400	\$1,188,600
Heat Recovery	\$13,500	\$0	\$0	\$0	\$0	\$275,000
Fuel Gas Compression	\$8,700	\$16,400	\$42,600	\$0	\$0	\$164,000
Interconnection	\$0	\$0	\$0	\$0	\$0	\$0
Total Equipment (\$)	\$75,300	\$129,300	\$401,900	\$441,200	\$566,400	\$1,627,600
(\$/kW)	\$2,689	\$2,120	\$2,120	\$1,840	\$1,770	\$1,710
Installation Costs						
Labor/Materials	\$22,600	\$28,400	\$80,400	\$83,800	\$101,900	\$293,000
Project & Construction Mgmt	\$9,000	\$15,500	\$48,200	\$52,900	\$68,000	\$195,300
Engineering and Fees	\$9,000	\$15,500	\$44,200	\$48,500	\$56,600	\$162,800
Project Contingency	\$3,800	\$6,500	\$20,100	\$22,100	\$28,300	\$81,400
Financing (int. during const.)	\$700	\$1,200	\$3,700	\$4,100	\$5,100	\$14,800
Total Other Costs (\$)	\$45,100	\$67,100	\$196,600	\$211,400	\$259,900	\$747,300
(\$/kW)	\$1,611	\$1,100	\$1,035	\$881	\$812	\$787
Total Installed Cost (\$)	\$120,400	\$196,400	\$598,500	\$652,600	\$826,300	\$2,374,900
(\$/kW)	\$4,300	\$3,220	\$3,150	\$2,720	\$2,580	\$2,500

Source: Microturbine package costs and equipment from the vendors; installation costs developed by ICF.

As the table shows, there are economies of scale as sizes get larger. From 30 to 333 kW capital costs increase as the 0.8 power factor of the capacity increase⁸⁶ – a 100 percent increase in size results in an 80 percent increase in capital cost. Similar scale economies also exist for multiple unit installations such as the 1,000 kW unit comprised of five 200-kW units. The unit cost of the larger system is only 80 percent of the cost of the single unit.

5.4.4 Maintenance

Maintenance costs vary with size, fuel type and technology (air versus oil bearings). A typical maintenance schedule is shown in **Table 5-4**.

Table 5-4. Example Service Schedule, Capstone C65

Maintenance Interval	Component	Maintenance Action	Comments
24 months	UCB Battery	Replace	---
4,000 hours	Engine Air Filter	Inspect	Replace if application requires
	Electronics Air Filter	Inspect	Clean if necessary
	Fuel Filter Element (external)	Inspect	Replace if application requires (not required for gas pack)

⁸⁶ $(Cost_1/Cost_2) = (Size_1/Size_2)^{0.8}$

Table 5-4. Example Service Schedule, Capstone C65

Maintenance Interval	Component	Maintenance Action	Comments
	Fuel System	Leak Check	---
8,000 hours	Engine Air Filter	Replace	---
	Electronics Air Filter	Clean	---
	Fuel Filter Element (external)	Replace	Not required for gas pack
	Igniter	Replace	---
	ICHP Actuator	Replace	---
20,000 hours or 3 years	Battery Pack	Replace	---
20,000 hours	Injector Assemblies	Replace	---
	TET Thermocouple	Replace	---
	SPV	Replace	Replace with Woodward valve upgrade kit
40,000 hours	Electronic Components: ECM, LCM, & BCM Power Boards, BCM & ECM Fan Filters, Fans, EMI Filter, Frame PM	Replace	Kits available for each major configuration
	Engine	Replace	Remanufactured or new

Source: Adapted from Capstone C65 User’s Manual.

Most manufacturers offer service contracts that cover scheduled and unscheduled events. The cost of a full service contract covers the inspections and component replacements outlined in **Table 5-5**, including replacement or rebuild of the main turbocompressor engine components. Full service costs vary according to fuel type and service as shown.

Table 5-5. Maintenance Costs Based on Factory Service Contracts

Maintenance Costs	System					
	1	2	3	4	5	6
Nominal Electricity Capacity (kW)	30	65	200	250	333	1000
Fixed (\$/kW/yr)	---	---	---	\$9.120	\$6.847	---
Variable (\$/kWh)	---	---	---	\$0.010	\$0.007	---
Average @ 6,000 hrs/year operation (\$/kWh)	---	\$0.013	\$0.016	\$0.011	\$0.009	\$0.012

Source: Compiled by ICF from vendor supplied data

Maintenance requirements can be affected by fuel type and site conditions. Waste gas and liquid fuel applications may require more frequent inspections and component replacement than natural gas systems. Microturbines operating in dusty and/or dirty environments require more frequent inspections and filter replacements.

5.4.5 Fuels

Stationary microturbines have been designed to use natural gas as their primary fuel. Microturbines designed for transportation applications typically utilize a liquid fuel such as methanol. As previously noted, microturbines are capable of operating on a variety of fuels including:

- **Liquefied petroleum gas (LPG)** – propane and butane mixtures
- **Sour gas** – unprocessed natural gas as it comes directly from a gas well
- **Biogas** – any of the combustible gases produced from biological degradation of organic wastes, such as landfill gas, sewage digester gas, and animal waste digester gas
- **Industrial waste gases** – flare gases and process off-gases from refineries, chemical plants and steel mills
- **Manufactured gases** – typically low- and medium-Btu gas produced as products of gasification or pyrolysis processes

Some of the elements work as contaminants and are a concern with some waste fuels, specifically the acid gas components (H₂S, halogen acids, HCN, ammonia, salts and metal-containing compounds, halogens, nitrogen compounds, and silicon compounds) and oils. In combustion, halogen and sulfur compounds form halogen acids, SO₂, some SO₃, and possibly H₂SO₄ emissions. The acids can also corrode downstream equipment. Solid particulates must be kept to low concentrations to prevent corrosion and erosion of components. Various fuel scrubbing, droplet separation, and filtration steps are required if fuel contaminant levels exceed manufacturer specifications. Landfill gas in particular often contains chlorine compounds, sulfur compounds, organic acids, and silicon compounds which dictate fuel pretreatment. A particular concern with wastewater treatment and landfill applications is the control of siloxane compounds. Siloxanes are a prevalent manmade organic compound used in a variety of products, and they eventually find their way into landfills and waste water. When siloxanes are exposed to high temperatures inside the combustion and exhaust sections of the turbine, they form hard silicon dioxide deposits that can eventually lead to turbine failure.

5.4.6 System Availability

Microturbine systems in the field have generally shown a high level of availability.⁸⁷ The basic design and low number of moving parts is conducive to high availability; manufacturers have targeted availabilities of 98-99 percent. The use of multiple units or backup units at a site can further increase the availability of the overall facility.

5.5 Emissions

Microturbines are designed to meet State and federal emissions regulations including more stringent State emissions requirements such as in California and other states (e.g., the Northeast). All microturbines operating on gaseous fuels feature lean premixed (dry low NO_x, or DLN) combustor technology. All of the example commercial units have been certified to meet extremely stringent standards in Southern California of less than 4-5 ppmvd of NO_x (15 percent O₂.) After employing a CO/VOC oxidation catalyst, carbon monoxide (CO) and volatile organic compound (VOC) emissions are at

⁸⁷ Availability refers to the percentage of time that the system is either operating or available to operate. Conversely, the system is unavailable when it is shut down for maintenance or when there has been a forced outage.

the same level. “Non-California” versions have NO_x emissions of less than 9 ppmvd. The emissions characteristics are shown in **Table 5-6**.

Table 5-6. Microturbine Emissions Characteristics

	System					
	1	2	3	4	5	6
Nominal Electric Capacity (kW)	30	65	200	240	320	1,000
Recovered Thermal Energy (kW)	61.0	119.8	258.9	376	450	1,299.0
Nominal Electrical Efficiency, HHV	23.6%	25.3%	28.1%	27.2%	29.2%	28.1%
NO _x (ppm @ 15% O ₂ , dry) [1]	9	4	4	5	9	4
NO _x (lb/MWh) [2]	0.49	0.17	0.14	0.23	0.39	0.14
NO _x (lb/MWh with CARB CHP credit)	0.16	0.06	0.06	0.09	0.16	0.06
CO (ppm @ 15% O ₂ , dry) [1]	40	8	8	5	10	8
CO (lb/MWh) [3]	1.8	0.24	0.2	0.14	0.26	0.2
CO (lb/MWh with CARB CHP credit)	0.59	0.08	0.09	0.06	0.11	0.09
VOC (ppm @ 15% O ₂ , dry) [1, 4]	9	3	3	5	9	3
VOC (lb/MWh) [5]	0.23	0.05	0.2	0.08	0.13	0.2
VOC (lb/MWh with CARB CHP credit)	0.08	0.02	0.09	0.03	0.06	0.09
CO ₂ (lb/MWh electric only) [6]	1,814	1,680	1,497	1,530	1,424	1,497
CO ₂ (lb/MWh with CARB CHP credit)	727	700	817	749	722	815

Notes:

1. Vendor estimates for low emission models using natural gas fuel. For systems 1, 2, 3, and 6 the vendor provided both input- (ppmv) and output-based emissions (lb/MWh.) For units 4 and 5, the output emissions were calculated as described below.
2. Output based NO_x emissions (lb/MWh) = (ppm @15% O₂) X 3.413 / ((272 X (% efficiency HHV))
3. Output based CO emissions (lb/MWh) = (ppm @15% O₂) X 3.413 / ((446 X (% efficiency HHV))
4. Volatile organic compounds.
5. Output based VOC emissions (lb/MWh) = (ppm @15% O₂) X 3.413 / ((782 X (% efficiency HHV))
6. Based on 116.39 lbs CO₂ / MMBtu.

The CO₂ emissions estimates with CHP show the potential of microturbines in CHP applications to reduce the emissions of CO₂. Coal fired generation emits about 2,000 lb/MWh, and even state of the art natural gas combined cycle power plants produce CO₂ emissions in the 800-900 lb/MWh range, even before transmission line losses are considered.

5.6 Future Developments

Microturbines first entered the market in the 30-75 kW size range. Of the last several years, microturbine manufacturers have developed larger capacity products to achieve better economics of operation through higher efficiencies and lower capital and maintenance costs.

Manufacturers are continuing to develop products with higher electrical efficiencies. Known developments include a model Capstone is developing, with the Department of Energy, on a 250 kW model with a target efficiency of 35 percent (gross output, LHV) and a 370 kW model with a projected 42 percent efficiency. The C250 is intended to feature an advanced aerodynamic compressor design,

engine sealing improvements, improved generator design with longer life magnet, and enhanced cooling.

Key technical developments of the C370 model, shown schematically in **Figure 5-8**, include:

- Dual property, high-temperature turbine
- High-pressure compressors (11:1) and recuperator
- Dual generators – both low pressure and high-pressure spool
- Dual spool control development
- High-temperature, low emissions combustor
- Inter-state compressor cooling

Figure 5-8. Capstone C370 Two-shaft High Efficiency Turbine Design

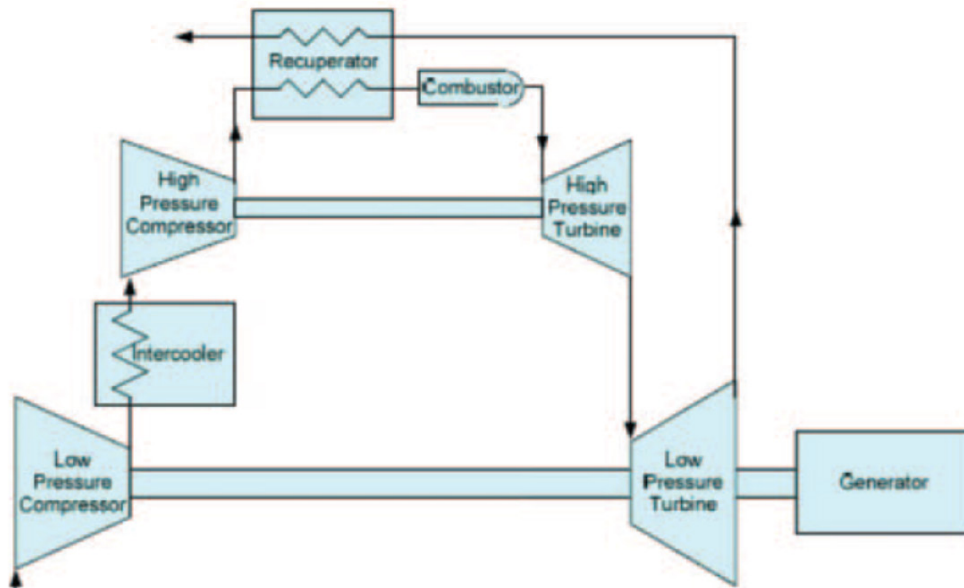

Source: DOE, Energy Efficiency and Renewable Energy Fact Sheet

The C370 model will use a modified Capstone C200 turbocompressor assembly as the low-pressure section of a two shaft turbine. This low-pressure section will have an electrical output of 250 kW. A new high-temperature, high-pressure turbocompressor assembly will increase the electrical output to 370 kW.

Section 6. Technology Characterization – Fuel Cells

6.1 Introduction

Fuel cell systems employ an entirely different approach to the production of electricity than traditional combustion based prime mover technologies. Fuel cells are similar to batteries in that they both produce a direct current (DC) through an electrochemical process without direct combustion of a fuel source. However, whereas a battery delivers power from a finite amount of stored energy, fuel cells can operate indefinitely, provided the availability of a continuous fuel source. Two electrodes (a cathode and anode) pass charged ions in an electrolyte to generate electricity and heat. A catalyst enhances the process.

Fuel cells offer the potential for clean, quiet, and efficient power generation. Because the fuel is not combusted, but instead reacts electrochemically, there is minimal air pollution associated with its use. Fuel cells have been under development for over 40 years as an emerging power source however, fuel cells of many different sizes are commercially available now. Based on their environmental benefits, high efficiency and virtually no emissions of criteria pollutants, fuel cells are supported by a number of state and federal tax incentive programs that help to offset the overall system costs. These incentives have been designed to promote continued fuel cell development, cost reductions, and overall market deployment.

The inventor of fuel cell technology was Sir William Grove, who demonstrated a hydrogen fuel cell in London in the 1830s. Grove's technology remained without a practical application for over 100 years. Fuel cells returned to the laboratory in the 1950s when the United States space program required the development of new power systems with low to no air emissions. Today, the topic of fuel cells encompasses a broad range of different technologies, technical issues, and market dynamics that make for a complex but promising outlook. Significant public and private investment are being applied to the development of fuel cell products for both stationary and transportation applications.

There are four primary types of fuel cells that are used for stationary combined heat and power (CHP) applications. These include: 1) phosphoric acid (PAFC), 2) molten carbonate (MCFC), 3) solid oxide (SOFC), and 4) proton exchange membrane (PEMFC). Two additional primary fuel cell types - direct methanol (DMFC) and alkaline (AFC) - are used primarily in transportation and non-stationary fuel cell applications, in addition to PEMFC.

The electrolyte and operating temperatures vary for each of the fuel cell types. Operating temperatures range from near-ambient to 1,800°F, and electrical generating efficiencies range from 30 percent to over 50 percent on a Higher Heating Value (HHV) basis. As a result, fuel cells can have different performance characteristics, advantages, and limitations, which can be suited to distributed generation applications in a variety of approaches. **Table 6-1** provides a summary of the primary advantages and disadvantages of the various types of fuel cells.

Table 6-1. Comparison of Fuel Cell Applications, Advantages, and Disadvantages

	Applications	Advantages	Disadvantages
Alkaline (AFC)	<ul style="list-style-type: none"> • Military • Space 	<ul style="list-style-type: none"> • Cathode reaction faster in alkaline electrolyte, leads to high performance • Low cost components 	<ul style="list-style-type: none"> • Sensitive to CO₂ in fuel and air • Electrolyte management
Direct Methanol (DMFC)	<ul style="list-style-type: none"> • Backup power • Portable power • Military 	<ul style="list-style-type: none"> • No need for reformer (catalyst separates H₂ from liquid methanol) • Low temperature 	<ul style="list-style-type: none"> • Expensive catalysts • Low temperature waste heat
Phosphoric Acid (PAFC)	<ul style="list-style-type: none"> • Auxiliary power • Electric utility • Distributed generation 	<ul style="list-style-type: none"> • Higher temperature enables CHP • Increased tolerance to fuel impurities 	<ul style="list-style-type: none"> • Platinum catalyst • Startup time • Low current and power
Proton Exchange Membrane (PEMFC)	<ul style="list-style-type: none"> • Backup power • Portable power • Distributed generation • Transportation • Specialty vehicles 	<ul style="list-style-type: none"> • Solid electrolyte reduces corrosion & electrolyte management problems • Low temperature • Quick startup 	<ul style="list-style-type: none"> • Expensive catalysts • Sensitive to fuel impurities • Low temperature waste heat
Molten Carbonate (MCFC)	<ul style="list-style-type: none"> • Auxiliary power • Electric utility • Distributed generation 	<ul style="list-style-type: none"> • High efficiency • Fuel flexibility • Can use a variety of catalysts • Suitable for CHP 	<ul style="list-style-type: none"> • High temperature corrosion and breakdown • Long startup time • Low power density
Solid Oxide (SOFC)	<ul style="list-style-type: none"> • Auxiliary power • Electric utility • Distributed generation 	<ul style="list-style-type: none"> • High efficiency • Fuel flexibility • Can use a variety of catalysts • Solid electrolyte • Suitable for CHP & Combined heat, hydrogen, and powerHybrid/GT cycle 	<ul style="list-style-type: none"> • High temperature corrosion and breakdown of cell components • High temperature operation requires long startup time and limits

Source: DOE Fuel Cell Technologies Program⁸⁸

While there are many different types of fuel cells, there are a few important shared characteristics. Instead of operating as Carnot cycle engines, or thermal energy-based engines, fuel cells use an electrochemical or battery-like process to convert the chemical energy of hydrogen into water and electricity and through this process achieve high electrical efficiencies. Second, fuel cells use hydrogen as the input fuel, which is typically derived from a hydrocarbon fuel such as natural gas or biogas. Third, most, but not all, fuel cell systems are composed of three primary subsystems: 1) the fuel cell stack that generates direct current electricity; 2) the fuel processor that converts the fuel (i.e. natural gas) into a hydrogen-rich feed stream; and 3) the power conditioner that processes the electric energy into alternating current or regulated direct current. There are a small number of special application fuel cell systems that are designed to operate on stored hydrogen fuel, and those fuel cells are configured to utilize the DC power output directly.

As previously mentioned, all types of fuel cells also have low emissions profiles. This is because the only combustion processes are the reforming of natural gas or other fuels to produce hydrogen and the burning of a low energy hydrogen exhaust stream to provide heat to the fuel processor.

Current CHP fuel cell installations total about 83.6 MW domestically.⁸⁹ California leads the nation in fuel cell installations, with just under 45 MW, roughly split half natural gas and half biogas. Connecticut and New York follow as the second and third-ranked states with current fuel cell installations at 25 MW and 10 MW, respectively. Those three states comprise 95 percent of the current domestic fuel cell market.

There is a significant amount of biogas fuel cells in California (representing almost a quarter of all fuel cell installations domestically by MW). Many of these systems were developed recently (i.e. 2010) as a result of additional incentives stemming from the California Self-Generation Incentive Program (SGIP).⁹⁰ Specifically, “directed biogas” projects (i.e. projects that consume biogas fuel produced at a different location) are eligible for higher incentives under the SGIP. Both CHP and electric-only fuel cells qualify for the SGIP incentive.

6.2 Applications

Fuel cells are either available or being developed for a number of stationary and vehicle applications. The power applications include commercial and industrial CHP (200-2800 kW), pure electrical generation⁹¹ (105-210 kW), residential and commercial systems for CHP (3-10 kW), back-up and portable power systems (0.25-5 kW). In DG markets, the primary characteristic driving early market acceptance is the ability of fuel cell systems to provide reliable premium power. The primary interest drivers have been their ability to achieve high efficiencies over a broad load profile and low emission signatures without additional controls. **Figure 6-1** illustrates an actual site with a fuel cell system functioning in CHP configuration.

⁸⁸ <http://energy.gov/eere/fuelcells/comparison-fuel-cell-technologies>

⁸⁹ CHP Installation Database. Maintained by ICF International for Oak Ridge National Laboratory. 2014. <http://www.eea-inc.com/chpdata/index.html>

⁹⁰ “2012 SGIP Impact Evaluation and Program Outlook” Itron. February 2014

⁹¹ Based on Bloom Energy models ES-5700, ES-5400, and UPM-570

Figure 6-1. Commercial Fuel Cell for CHP Application



Source: FuelCell Energy

6.2.1 Combined Heat and Power

Due to the high installed cost of fuel cell systems, the most prevalent and economical DG application is CHP. CHP applications are on-site power generation in combination with the recovery and use of by-product heat. Continuous baseload operation and the effective use of the thermal energy contained in the exhaust gas and cooling subsystems enhance the economics of on-site generation applications.

Heat is generally recovered in the form of hot water or low-pressure steam (<30 psig), but the quality of heat is dependent on the type of fuel cell and its operating temperature. PEMFC and DMFC operate at temperatures below 200°F, and therefore have low quality heat. Generally, the heat recovered from fuel cell CHP systems is appropriate for low temperature process needs, space heating, and potable water heating. In the case of SOFC and MCFC technologies, medium pressure steam (up to about 150 psig) can be generated from the fuel cell's high temperature exhaust gas, but the primary use of this hot exhaust gas is in recuperative heat exchange with the inlet process gases.

The simplest thermal load to supply is hot water. Primary applications for CHP in the commercial/institutional sectors are those building types with relatively high and coincident electric and hot water/space heating demand such as colleges and universities, hospitals, nursing homes, and lodging. Technology developments in heat activated cooling/refrigeration and thermally regenerated desiccants will enhance fuel cell CHP applications by increasing the thermal energy loads in certain building types. Use of these advanced technologies in applications such as restaurants, supermarkets, and refrigerated warehouses provides a base-thermal load that opens these applications to CHP.

6.2.2 Premium Power

Consumers who require higher levels of reliability or power quality, and are willing to pay for it, often find some form of DG to be advantageous. These consumers are typically less concerned about the initial prices of power generating equipment than other types of consumers. Premium power systems generally supply base load demand. As a result, and in contrast to back-up generators, emissions and efficiency become more significant decision criteria.

Fuel cell systems offer a number of intrinsic features that make them suitable for the premium power market. These market-driving features include low emissions/vibration/noise, high availability, good power quality, and compatibility with zoning restrictions. As emissions become more relevant to a

business's bottom line in the form of zoning issues and emissions credits, fuel cells become a more appealing type of DG.

Some types of fuel cell systems have already demonstrated high availability and reliability. As fuel cells further mature in the market, they are expected to achieve the high reliability associated with fewer moving parts.

While fuel cells require significant power conditioning equipment in the form of direct current to alternating current conversion, power from fuel cell systems is clean, exhibiting none of the signal disturbances observed from grid sources.

Finally, zoning for fuel cell systems is easier than other types of DG systems. Fuel cell systems can be designed for both indoor and outdoor installation, and in close proximity to sensitive environments, people, or animals.

6.2.3 Remote Power

In locations where power from the local grid is unavailable or extremely expensive to install, DG is a competitive option. As with premium power, remote power applications are generally base load operations. Consequently, emissions and efficiency become more significant criteria in much of the remote power DG market. Coupled with their other potential advantages, fuel cell systems can provide competitive energy into certain segments of the remote power DG market. Where fuel delivery is problematic, the high efficiency of fuel cell systems can also be a significant advantage.

6.2.4 Grid Support

One of the first applications that drew the attention of electric utilities to fuel cell technologies was grid support. Numerous examples of utility-owned and operated distributed generating systems exist in the U.S. and abroad. The primary application in the U.S. has been the use of relatively large diesel or natural gas engines for peaking or intermediate load service at municipal utilities and electric cooperatives. These units provide incremental peaking capacity and grid support for utilities at substations. Such installations can defer the need for T&D system expansion, can provide temporary peaking capacity within constrained areas, or be used for system power factor correction and voltage support, thereby reducing costs for both customers and the utility system. The unique feature of fuel cell systems is the use of power conditioning inverters to transform direct current electricity into alternating current. These power conditioners can be operated almost independent of the fuel cell to correct power factors and harmonic characteristics in support of the grid if there is enough capacity.

6.2.5 Peak Shaving

In certain areas of the country, customers and utilities are using on-site power generation to reduce the need for costly peak-load power. Peak shaving is also applicable to customers with poor load factor and/or high demand charges. Typically, peak shaving does not involve heat recovery, but heat recovery may be warranted where the peak period is more than 2,000 hours/year. Since low equipment cost and high reliability are the primary requirements, equipment such as reciprocating engines are ideal for many peak-shaving applications. Emissions may be an issue if operating hours are high. Combining peak shaving and another function, such as standby power, enhances the economics. High capital cost and

relatively long start-up times (particularly for MCFC and SOFC) will most likely prevent the widespread use of fuel cells in peak shaving applications.

6.2.6 Resiliency

Fuel cells can be configured to operate independently of the grid, and can therefore provide emergency power during outages. This was evident particularly during recent hurricane events, where significant power outages occurred. For instance, during Hurricanes Irene and Superstorm Sandy, fuel cells helped keep communication lines open for different communications service providers.⁹² Fuel cells are also generally resilient based on the undergrounded natural gas supply.

6.3 Technology Description

Fuel cells produce direct current electricity through an electrochemical process, much like a standard battery. Unlike a standard battery, a fuel supply continuously replenishes the fuel cell. The reactants, most typically hydrogen and oxygen gas, are fed into the fuel cell reactor, and power is generated as long as these reactants are supplied. The hydrogen (H₂) is typically generated from a hydrocarbon fuel such as natural gas or LPG, and the oxygen (O₂) is from ambient air.

6.3.1 Basic Processes and Components

Fuel cell systems designed for DG applications are primarily natural gas or LPG fueled systems. Each fuel cell system consists of three primary subsystems: 1) the fuel cell stack that generates direct current electricity; 2) the fuel processor that converts the natural gas into a hydrogen rich feed stream; and 3) the power conditioner that processes the electric energy into alternating current or regulated direct current.

Figure 6-2 illustrates the electrochemical process in a typical single cell, acid-type fuel cell. A fuel cell consists of a cathode (positively charged electrode), an anode (negatively charged electrode), an electrolyte and an external load. The anode provides an interface between the fuel and the electrolyte, catalyzes the fuel reaction, and provides a path through which free electrons conduct to the load via the external circuit. The cathode provides an interface between the oxygen and the electrolyte, catalyzes the oxygen reaction, and provides a path through which free electrons conduct from the load to the oxygen electrode via the external circuit. The electrolyte, an ionic conductive (non-electrically conductive) medium, acts as the separator between hydrogen and oxygen to prevent mixing and the resultant direct combustion. It completes the electrical circuit of transporting ions between the electrodes.

⁹² *The Business Case for Fuel Cells, Reliability, Resiliency & Savings (2013)*. See www.fuelcells.org.

Figure 6-2. Fuel Cell Electrochemical Process

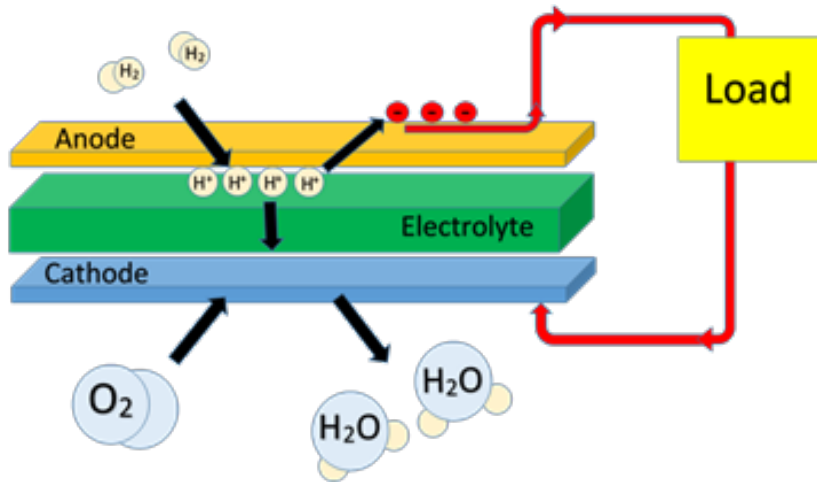

Source: ICF

The hydrogen and oxygen are fed to the anode and cathode, respectively. However, they do not directly mix, and result in combustion. Instead, the hydrogen oxidizes one molecule at a time, in the presence of a catalyst. Because the reaction is controlled at the molecular level, there is no opportunity for the formation of NO_x and other pollutants.

At the anode the hydrogen gas is electrochemically dissociated (in the presence of a catalyst) into hydrogen ions (H⁺) and free electrons (e⁻).



The electrons flow out of the anode through an external electrical circuit. The hydrogen ions flow into the electrolyte layer and eventually to the cathode, driven by both concentration and potential forces. At the cathode the oxygen gas is electrochemically combined (in the presence of a catalyst) with the hydrogen ions and free electrons to generate water.



The overall reaction in a fuel cell is as follows:

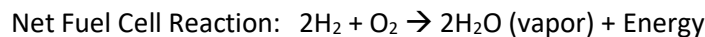

When generating power, electrons flow through the external circuit, ions flow through the electrolyte layer and chemicals flow into and out of the electrodes. Each process has natural resistances, and overcoming these reduces the operational cell voltage below the theoretical potential. There are also irreversible processes⁹³ that affect actual open circuit potentials. Therefore, some of the chemical potential energy converts into heat. The electrical power generated by the fuel cell is the product of the

⁹³ An irreversible process is a change in the potential energy of the chemical that is not recovered through the electrochemical process. Typically, some of the potential energy is converted into heat even at open circuit conditions when current is not flowing. A simple example is the resistance to ionic flow through the electrolyte while the fuel cell is operating. This potential energy “loss” is really a conversion to heat energy, which cannot be reconverted into chemical energy directly within the fuel cell.

current measured in amps and the operational voltage. Based on the application and economics, a typical operating fuel cell will have an operating voltage of between 0.55 volts and 0.80 volts. The ratio of the operating voltage and the theoretical maximum of 1.48 volts represents a simplified estimate of the stack electrical efficiency on a HHV⁹⁴ basis.

As described above, resistance heat is also generated along with the power. Since the electric power is the product of the operating voltage and the current, the quantity of heat that must be removed from the fuel cell is the product of the current and the difference between the theoretical potential and the operating voltage. In most cases, the water produced by the fuel cell reactions exits the fuel cell as vapor, and therefore, the 1.23-volt LHV theoretical potential is used to estimate sensible heat generated by the fuel cell electrochemical process.

The overall electrical efficiency of the cell is the ratio of the power generated and the heating value of the hydrogen consumed. The maximum thermodynamic efficiency of a hydrogen fuel cell is the ratio of the Gibbs free energy and the heating value of the hydrogen. The Gibbs free energy decreases with increasing temperatures, because the product water produced at the elevated temperature of the fuel cell includes the sensible heat of that temperature, and this energy cannot be converted into electricity without the addition of a thermal energy conversion cycle (such as a steam turbine). Therefore, the maximum efficiency of a pure fuel cell system decreases with increasing temperature. **Figure 6-3** illustrates this characteristic in comparison to the Carnot cycle efficiency limits through a condenser at 50 and 100°C⁹⁵. This characteristic has led system developers to investigate hybrid fuel cell-turbine combined cycle systems to achieve system electrical efficiencies in excess of 70 percent HHV.

⁹⁴ Most of the efficiencies quoted in this report are based on higher heating value (HHV), which includes the heat of condensation of the water vapor in the products.

⁹⁵ Larminie, James and Andrew Dicks, [Fuel Cell Systems Explained](#). John Wiley & Sons, Ltd., West Sussex, England, 2000.

Figure 6-3. Effect of Operating Temperature on Fuel Cell Efficiency

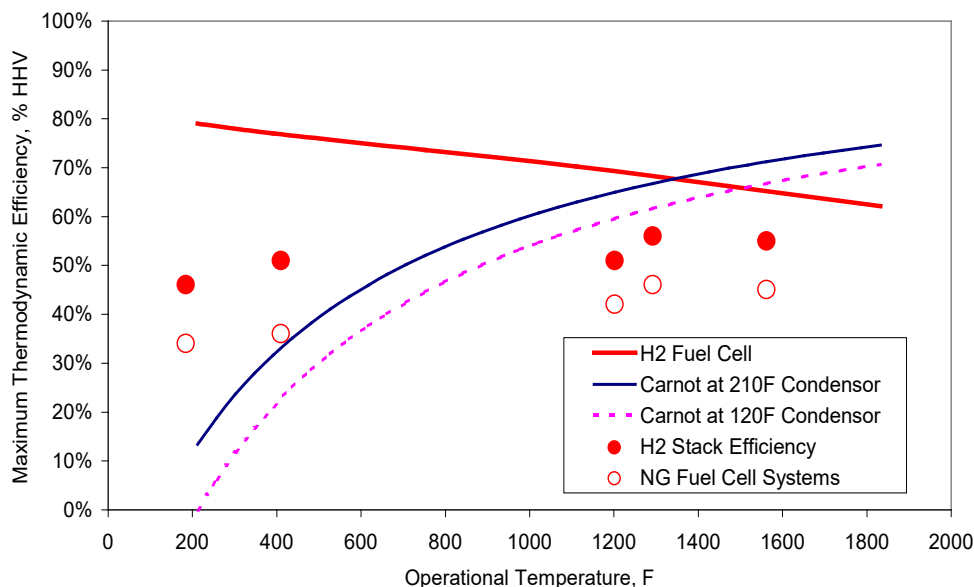

Source: Larminie, James and Andrew Dicks, *Fuel Cell Systems Explained*. John Wiley & Sons, Ltd., West Sussex, England, 2000.

6.3.1.1 Fuel Cell Stacks

Practical fuel cell systems require voltages higher than 0.55 to 0.80. Combining several cells in electrical series into a fuel cell stack achieves this. Typically, there are several hundred cells in a single cell stack. Increasing the active area of individual cells manages current flow. Typically, cell area can range from 100 cm² to over 1 m² depending on the type of fuel cell and application power requirements.

6.3.1.2 Fuel Processors

In distributed generation applications, the most viable fuel cell technologies use natural gas (CH₄) as the system's fuel source. To operate on natural gas or other fuels, fuel cells require a fuel processor or reformer, a device that converts the natural gas fuel into a hydrogen-rich gas stream. While adding fuel flexibility to the system, the reformer also adds significant cost and complexity. There are three primary types of reformers: steam reformers, autothermal reformers, and partial oxidation reformers. The fundamental differences are the source of oxygen used to combine with the carbon within the fuel to release the hydrogen gases and the thermal balance of the chemical process. Steam reformers use steam, while partial oxidation units use oxygen gas, and autothermal reformers use both steam and oxygen.

Steam reforming is extremely endothermic and requires a substantial amount of heat input. Autothermal reformers typically operate at or near the thermal neutral point, and therefore, do not generate or consume thermal energy. Partial oxidation units combust a portion of the fuel (i.e. partially oxidize it), releasing heat in the process. When integrated into a fuel cell system that allows the use of anode-off gas, a typical natural gas reformer can achieve conversion efficiencies in the 75 to 90 percent LHV range, with 83 to 85 percent being an expected level of performance. These efficiencies are defined as the LHV of hydrogen generated divided by the LHV of the natural gas consumed by the reformer.

Some fuel cells can function as internally steam reforming fuel cells. Since the reformer is an endothermic catalytic converter and the fuel cell is an exothermic catalytic oxidizer, the two combine into one with mutual thermal benefits. More complex than a pure hydrogen fuel cell, these types of fuel cells are more difficult to design and operate. While combining two catalytic processes is difficult to arrange and control, these internally reforming fuel cells are expected to account for a significant market share as fuel cell based DG becomes more common.

It is also during this process, depending on the efficiency of the fuel cell, that CO₂ is emitted as part of the reforming of the natural gas into usable hydrogen. CO₂ emissions range between 700 to 900 lb/MWh depending on the fuel cell technology used.

6.3.1.3 Power Conditioning Subsystem

Fuel cells generate direct current electricity, which requires conditioning before serving a load. Depending on the cell area and number of cells, this direct current electricity is approximately 200 to 400 volts per stack. If the system is large enough, stacks can operate in series to double or triple individual stack voltages. Since the voltage of each individual cell decreases with increasing load or power, the output is considered an unregulated voltage source. The power conditioning subsystem boosts the output voltage to provide a regulated higher voltage input source to an electronic inverter. The inverter then uses a pulse width modulation technique at high frequencies to generate alternating current output. The inverter controls the frequency of the output, which can be adjusted to enhance power factor characteristics. Because the inverter generates alternating current within itself, the output power is generally clean and reliable. This characteristic is important to sensitive electronic equipment in premium power applications. The efficiency of the power conditioning process is typically 92 to 96 percent, and is dependent on system capacity and input voltage-current characteristic.

6.3.1.4 Types of Fuel Cells

There are four basic types of fuel cells most suitable for stationary CHP applications. The fuel cell's electrolyte or ion conduction material defines the basic type. Two of these fuel cell types, polymer electrolyte membrane (PEMFC) and phosphoric acid fuel cell (PAFC), have acidic electrolytes and rely on the transport of H⁺ ions. Carbonate fuel cell (MCFC) has basic electrolytes that rely on the transport of CO₃²⁻ ions. The fourth type, solid oxide fuel cell (SOFC), is based on a solid-state ceramic electrolyte in which oxygen ions (O₂⁻) are the conductive transport ion.

Each fuel cell type operates at an optimum temperature, which is a balance between the ionic conductivity and component stability. These temperatures differ significantly among the four basic types, ranging from near ambient to as high as 1800°F. The proton conducting fuel cell type generates water at the cathode and the anion conducting fuel cell type generates water at the anode.

Table 6-2 presents fundamental characteristics for the primary fuel cell types most suitable for stationary CHP.

Table 6-2. Characteristics of Major Fuel Cell Types

	PEMFC	PAFC	MCFC	SOFC
Type of Electrolyte	H ⁺ ions (with anions bound in polymer membrane)	H ⁺ ions (H ₃ PO ₄ solutions)	CO ₃ ⁻ ions (typically, molten LiKaCO ₃ eutectics)	O ⁻ ions (Stabilized ceramic matrix with free oxide ions)
Common Electrolyte	Solid polymer membrane	Liquid phosphoric acid in a lithium aluminum oxide matrix	Solution of lithium, sodium, and/or potassium carbonates soaked in a ceramic matrix	Solid ceramic, Ytria stabilized zirconia (YSZ)
Typical construction	Plastic, metal or carbon	Carbon, porous ceramics	High temp metals, porous ceramic	Ceramic, high temp metals
Internal reforming	No	No	Yes, good temp match	Yes, good temp match
Oxidant	Air to O ₂	Air to Enriched Air	Air	Air
Operational Temperature	150- 180°F (65-85°C)	302-392°F (150-200°C)	1112-1292°F (600-700°C)	1202-1832°F (700-1000°C)
DG System Level Efficiency (% HHV)	25 to 35%	35 to 45%	40 to 50%	45 to 55%
Primary Contaminate Sensitivities	CO, Sulfur, and NH ₃	CO < 1%, Sulfur	Sulfur	Sulfur

Source: DOE Fuel Cells Technology Program⁹⁶

6.3.1.5 PEMFC (Proton Exchange Membrane Fuel Cell or Polymer Electrolyte Membrane)

NASA developed this type of fuel cell in the 1960s for the first manned spacecraft. The PEMFC uses a solid polymer electrolyte and operates at low temperatures (less than 200°F). Due to their modularity and simple manufacturing, reformer/PEMFC systems for residential DG applications (i.e. micro CHP) have enjoyed considerable market success, particularly in Asia. PEMFC's have high power density and can vary their output quickly to meet demand. This type of fuel cell is highly sensitive to CO poisoning. PEMFCs have historically been the market leader in terms of number of fuel cell units shipped. There is a wide range of PEMFC manufacturers.

6.3.1.6 PAFC (Phosphoric Acid Fuel Cell)

PAFC uses phosphoric acid as the electrolyte and is one of the most established fuel cell technologies. The first PAFC DG system was designed and demonstrated in the early 1970s. PAFCs are capable of fuel-to-electricity efficiencies of 36 percent HHV or greater. The current 400 kW product has a stack lifetime of over 40,000 hours and commercially based reliabilities in the 90 to 95 percent range. ClearEdge

⁹⁶ "2012 Fuel Cell Technologies Market Report" U.S. Department of Energy, October 2013. http://energy.gov/sites/prod/files/2014/03/f11/2012_market_report.pdf

Power is a primary US manufacturer of PAFC systems after buying the PAFC assets from United Technologies. Recently however ClearEdge has encountered financial problems.⁹⁷

6.3.1.7 MCFC (Molten Carbonate Fuel Cell)

The MCFC uses an alkali metal carbonate (Li, Na, K) as the electrolyte and has a developmental history that dates back to the early part of the twentieth century. Due to its operating temperature range of 1,100 to 1,400°F, the MCFC holds promise in CHP applications. This type of fuel cell can be internally reformed, can operate at high efficiencies (50 percent HHV), and is relatively tolerant of fuel impurities. Government/industry R&D programs during the 1980s and 1990s resulted in several individual pre-prototype system demonstrations. Fuel Cell Energy is one of the primary manufacturers of commercially available MCFCs, ranging from 300 kW to 2800 kW.

6.3.1.8 SOFC (Solid Oxide Fuel Cell)

SOFC uses solid, nonporous metal oxide electrolytes and is generally considered less mature in its development than the MCFC and PAFC technologies. SOFC has several advantages (high efficiency, stability and reliability, and high internal temperatures) that have attracted development support. The SOFC has projected service electric efficiencies of 45 to 60 percent and higher, for larger hybrid, combined cycle plants. Efficiencies for smaller SOFC units are typically in the 50 percent range.

Stability and reliability of the SOFC are due to an all-solid-state ceramic construction. Test units have operated in excess of 10 years with acceptable performance. The high internal temperatures of the SOFC are both an asset and a liability. As an asset, high temperatures make internal reforming possible. As a liability, these high temperatures add to materials and mechanical design difficulties, which reduce stack life and increase cost. While SOFC research has been ongoing for 30 years, costs of these stacks are still comparatively high. Currently, two of the primary SOFC manufacturers include Bloom Energy, which is a pure electric fuel cell (i.e. no waste heat is captured) and Ceramic Fuel Cells.

Design Characteristics

The features that have the potential to make fuel cell systems a leading prime mover for CHP and other distributed generation applications include:

Size range	Fuel cell systems are constructed from individual cells that generate 100 W to 2 kW per cell. This allows systems to have extreme flexibility in capacity. Multiple systems can operate in parallel at a single site to provide incremental capacity.
Thermal output	Fuel cells can achieve overall efficiencies in the 65 to 95% range. Waste heat can be used primarily for domestic hot water applications and space heating.
Availability	Commercially available systems have demonstrated greater than 90% availability.
Part-load operation	Fuel cell stack efficiency improves at lower loads, which results in a system electric efficiency that is relatively steady down to one-third to one-quarter of rated capacity. This provides systems with excellent load following characteristics.
Cycling	While part-load efficiencies of fuel cells are generally high, MCFC and SOFC fuel cells require long heat-up and cool-down periods, restricting their ability to operate in many cyclic applications.

⁹⁷ ClearEdge Power filed for Chapter 11 bankruptcy in May of 2014.

http://www.oregonlive.com/business/index.ssf/2014/05/clearedge_power_files_for_bankruptcy_as_financial_woes_mount.html

High-quality power	Electrical output is computer grade power, meeting critical power requirements without interruption. This minimizes lost productivity, lost revenues, product loss, or opportunity cost.
Reliability and life	While the systems have few moving parts, stack assemblies are complex and have had problems with seals and electrical shorting. Recommended stack rebuilds required every 5-10 years are expensive.
Emissions	The only combustion within a fuel cell system is the low energy content hydrogen stream exhausted from the stack when using pure hydrogen as a fuel source. This stream is combusted within the reformer and can achieve emissions
	Signatures of < 2 ppmv CO, <1 ppmv NO _x and negligible SO _x (on 15% O ₂ , dry basis). However most fuel cells need to convert natural gas (CH ₄) to hydrogen (H ₂). During this process CO ₂ is emitted at varying levels based on the efficiency of the fuel cell.
Efficiency	Different types of fuel cells have varied efficiencies. Depending on the type and design, electric efficiency ranges from 30% to close to 50% HHV.
Quiet operation	Conversational level (60dBA @ 30 ft.), acceptable for indoor installation.
Siting and size	Indoor or outdoor installation with enclosure.
Fuel use	The primary fuel source for fuel cells is hydrogen, which can be obtained from natural gas, coal gas, methanol, and other fuels containing hydrocarbons.

6.4 Performance Characteristics

Fuel cell performance is a function of the type of fuel cell and its capacity. Since the fuel cell system is a series of chemical, electrochemical, and electronic subsystems, the optimization of electric efficiency and performance characteristics can be a challenging engineering task. The electric efficiency calculation example provided in the next section illustrates this.

Table 6-3 summarizes performance characteristics for representative commercially available and developmental natural gas fuel cell CHP systems over the 0.7 kW to 1,400 kW size range. This size range covers the majority of the market applications. All systems included in **Table 6-3** are commercially available as of 2014.

Table 6-3. Fuel Cell CHP - Typical Performance Parameters

Performance Characteristics	System 1	System 2	System 3	System 4	System 5
Fuel Cell Type	PEMFC	SOFC	MCFC	PAFC	MCFC
Nominal Electricity Capacity (kW)	0.7	1.5	300	400	1,400
Net Electrical Efficiency (%), HHV	35.3%	54.4%	47%	34.3%	42.5%
Fuel Input (MMBtu/hr), HHV	0.0068	0.0094	2.2	4.0	11.2
Total CHP Efficiency (%), HHV	86%	74%	82%	81%	82%
Power to Heat Ratio	0.70	2.78	1.34	0.73	1.08
Net Heat Rate (Btu/kWh), HHV	9,666	6,272	7,260	9,948	8,028
Exhaust Temperature (°F)	NA	NA	700	NA	700
Available Heat (MMBtu/hr)	NA	NA	0.78 (to 120°F)	0.88 (to 140°F)	3.73 (to 120°F)
Sound (dBA)	NA	47 (at 3 feet)	72 (at 10 feet)	65 (at 33 feet)	72 (at 10 feet)

NA = not available or not applicable

Source: ICF, specific product specification sheets

Heat rates and efficiencies shown were taken from manufacturers' specifications and industry publications or are based on the best available data for developing technologies. CHP thermal recovery estimates are based on producing low quality heat for domestic hot water process or space heating needs. This feature is generally acceptable for commercial/institutional applications where it is more common to have hot water thermal loads.

Generally, electrical efficiency increases as the operating temperature of the fuel cell increases. SOFC fuel cells have the highest operating temperatures (which can be advantageous as well as disadvantageous) and they also have the highest electric efficiencies. In addition, as electrical efficiency increases, the absolute quantity of thermal energy available to produce useful thermal energy decreases per unit of power output, and the ratio of power to heat for the CHP system generally increases. A changing ratio of power to heat impacts project economics and may affect the decisions that customers make in terms of CHP acceptance, sizing, and the desirability of selling power.

6.4.1 Electrical Efficiency

As with all generation technologies, the electrical efficiency is the ratio of the power generated and the heating value of the fuel consumed. Because fuel cells have several subsystems in series, the electrical efficiency of the unit is the multiple of the efficiencies of each individual section. The electric efficiency of a fuel cell system is calculated as follows:

$$Eff_{Elec} = (Eff_{FPS} * H_2 \text{ Utilization} * Eff_{Stack} * Eff_{PC}) * (HHV/LHV \text{ ratio of the fuel})$$

Where:

- Eff_{FPS} = Fuel Processing Subsystem Efficiency, LLV (LHV of H₂ Generated/LHV of Fuel Consumed)
- H₂ Utilization = % of H₂ actually consumed in the stack
- Eff_{Stack} = (Operating Voltage/Energy Potential ~1.23 volts)
- Eff_{PC} = AC power delivered/(dc power generated) (auxiliary loads are assumed dc loads here)

For example, the electrical efficiency of a PAFC can be calculated as follows:

$$Eff_{Elec} = (84\%FPS) * (83\% \text{ util}) * (0.75V/1.25V) * (95\%PC) * (0.9HHV/LHV) \\ = 36\% \text{ electric efficiency HHV}$$

As the operating temperature range of the fuel cell system increases, the electric efficiency of the system tends to increase. Although the maximum thermodynamic efficiency decreases as shown in **Figure 6-3**, improvements in reformer subsystem integration and increases in reactant activity balance out to provide the system level increase. Advanced high temperature MCFC and SOFC systems can achieve simple cycle efficiencies in the range of 50 to 60 percent HHV, while hybrid combined fuel cell-heat engine systems are calculated to achieve efficiencies above 60 percent in DG applications.

6.4.2 Part Load Performance

In CHP applications, fuel cell systems are expected to follow the thermal load of the host site to maximize CHP energy economics. **Figure 6-4** shows the part load efficiency curve for a PAFC fuel cell in the 100 kW to 400 kW size range in comparison to a typical lean burn natural gas engine. It shows that

fuel cells maintain efficient performance at partial loads better than reciprocating engines. The fuel cell efficiency at 50 percent load is within 2 percent of its full load efficiency characteristic. As the load decreases further, the curve becomes somewhat steeper, as inefficiencies in air blowers and the fuel processor begin to override the stack efficiency improvement.

Figure 6-4. Comparison of Part Load Efficiency Derate

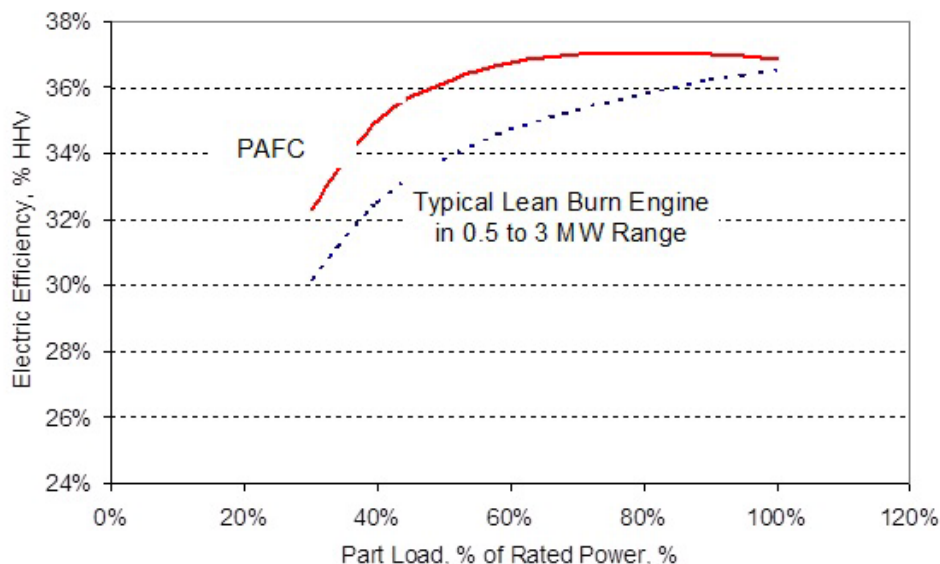

Source: Gas Technology Institute, Caterpillar, Energy Nexus Group.

6.4.3 Effects of Ambient Conditions on Performance

Fuel cells are generally rated at ISO conditions of 77° F and 0.987 atmospheres (1 bar) pressure. Fuel cell system performance – both output and efficiency – can degrade as ambient temperature or site elevation increases. This degradation in performance is related to ancillary equipment performance, primarily the air handling blowers or compressors. Performance degradations will be greater for pressurized systems operating with turbo-chargers or small air compressors as their primary air supply components.

6.4.4 Heat Recovery

The economics of fuel cells in on-site power generation applications depend less on effective use of the thermal energy recovered than is the case with lower efficiency prime movers, but thermal load displacements can improve operating economics as in any CHP application. Generally, 25 percent of the inlet fuel energy is recoverable from higher quality heat from the stack and reformer subsystems, and another 25 percent is contained in the exhaust gases that include the latent heat of the product water generated in the fuel cell. The most common use of this heat is to generate hot water or low-pressure steam for process use or for space heating.

Heat can generally be recovered in the form of hot water or low-pressure steam (< 30 psig), but the quality of heat is very dependent on the type of fuel cell and its operating temperature. The one exception to this is that some manufactures of SOFC do not recover the heat for use in other

applications but use the heat to boost the internal process and to improve electrical generation efficiencies.

As an example, there are four primary potential sources of usable waste heat from a fuel cell system: exhaust gas including water condensation, stack cooling, anode-off gas combustion, and reformer heat. A sample PAFC system achieves 36 percent electric efficiency and 72 percent overall CHP efficiency, which means that it has a 36 percent thermal efficiency or power to heat ratio of one. Of the available heat, 25 to 45 percent is recovered from the stack-cooling loop that operates at approximately 400° F and can deliver low- to medium-pressure steam. The balance of heat is derived from the exhaust gas-cooling loop that serves two functions. The first is condensation of product water, thus rendering the system water self-sufficient, and the second is the recovery of by-product heat. Since its primary function is water recovery, the balance of the heat available from the PAFC fuel cell is recoverable with 120° F return and 300° F supply temperatures. This tends to limit the application of this heat to domestic hot water applications. The other aspect to note is that all of the available anode-off gas heat and internal reformer heat is used internally to maximize system efficiency.

In the case of SOFC and MCFC fuel cells, medium-pressure steam (up to about 150 psig) can be generated from the fuel cell's high temperature exhaust gas, but the primary use of these hot exhaust gases is in recuperative heat exchange with the inlet process gases. Like engine and turbine systems, fuel cell exhaust gas can be used directly for process drying.

6.4.5 Performance and Efficiency Enhancements

Air is fed to the cathode side of the fuel cell stack to provide the oxygen needed for the power generation process. Typically, 50 to 100 percent more air is passed through the cathode than is required for the fuel cell reactions. The fuel cell can be operated at near-ambient pressure, or at elevated pressures to enhance stack performance. Increasing the pressure, and therefore the partial pressure of the reactants, increases stack performance by reducing the electrode over potentials associated with moving the reactants into the electrodes where the catalytic reaction occurs. It also improves the performance of the catalyst. These improvements appear to optimize at approximately three atmospheres pressure if optimistic compressor characteristics are assumed.⁹⁸ More realistic assumptions often result in optimizations at ambient pressure where the least energy is expended on air movement. Because of these characteristics, developers appear to be focused on both pressurized and ambient pressure systems.

6.4.6 Capital Cost

This section provides estimates for the installed cost of fuel cell systems designed for CHP applications. Capital costs (equipment and installation) are estimated in **Table 6-4** for five representative CHP fuel cell systems. Estimates are "typical" budgetary price levels. Installed costs can vary significantly depending on the scope of the plant equipment, geographical area, competitive market conditions, special site requirements, prevailing labor rates, and whether the system is a new or retrofit application.

⁹⁸ Larminie, James and Andrew Dicks, [Fuel Cell Systems Explained](#). John Wiley & Sons, Ltd., West Sussex, England, 2000. , p. 90.

Table 6-4. Estimated Capital and O&M Costs for Typical Fuel Cell Systems in Grid Interconnected CHP Applications (2014 \$/kW)

Installed Cost Components	System 1 Residential	System 2 Residential	System 3 C&I	System 4 C&I	System 5 C&I
Fuel Cell Type	PEMFC	SOFC	MCFC	PAFC	MCFC
Nominal Electricity Capacity (kW)	0.7	1.5	300	400	1400
Total Package Cost (2014 \$/kW) ⁹⁹	\$ 22,000	\$ 23,000 ¹⁰⁰	\$10,000	\$ 7,000	\$ 4,600
O&M Costs (2014 \$/MWh)	\$ 60	\$ 55	\$45	\$ 36	\$ 40

Source: ICF Manufacturer Data Collection

6.4.7 Maintenance

Maintenance costs for fuel cell systems will vary with type of fuel cell, size and maturity of the equipment. Some of the typical costs that need to be included are:

- Maintenance labor.
- Ancillary replacement parts and material such as air and fuel filters, reformer igniter or spark plug, water treatment beds, flange gaskets, valves, electronic components, etc., and consumables such as sulfur adsorbent bed catalysts and nitrogen for shutdown purging.
- Major overhauls include shift catalyst replacement (3 to 5 years), reformer catalyst replacement (5 years), and stack replacement (5 to 10 years).

Maintenance can either be performed by in-house personnel or contracted out to manufacturers, distributors or dealers under service contracts. Details of full maintenance contracts (covering all recommended service) and costing are not generally available, but are estimated at 0.7 to 2.0 cents/kWh excluding the stack replacement cost sinking fund. Maintenance for initial commercial fuel cells has included remote monitoring of system performance and conditions and an allowance for predictive maintenance. Recommended service is comprised of routine short interval inspections/adjustments and periodic replacement of filters (projected at intervals of 2,000 to 4,000 hours).

6.4.8 Fuels

Since the primary fuel source for fuel cells is hydrogen produced from hydrocarbon fuels, fuel cell systems can be designed to operate on a variety of alternative gaseous fuels including:

- **Natural Gas** – methane from the pipeline.
- **Liquefied petroleum gas (LPG)** – propane and butane mixtures.
- **Sour gas** - unprocessed natural gas as it comes directly from the gas well.
- **Biogas** – any of the combustible gases produced from biological degradation of organic wastes, such as landfill gas, sewage digester gas, and animal waste digester gas.
- **Industrial waste gases** – flare gases and process off-gases from refineries, chemical plants and steel mill.

⁹⁹ Total package cost includes all equipment (including heat recovery) as well as estimated labor and installation costs.

¹⁰⁰ Total package costs for larger (i.e. 200 kW) SOFC systems are significantly less expensive than \$23,000, however those data were not made available to us for estimation.

- **Manufactured gases** – typically low- and medium-Btu gas produced as products of gasification or pyrolysis processes.

Factors that impact the operation of a fuel cell system with alternative gaseous fuels include:

- **Volumetric heating value** – Since fuel is initially reformed by the fuel cell’s fuel processing subsystem, the lower energy content fuels will simply result in a less concentrated hydrogen-rich gas stream feeding the anode. This will cause some loss in stack performance, which can affect the stack efficiency, stack capacity or both. Increased pressure drops through various flow passages can also decrease the fine balance developed in fully integrated systems.
- Contaminants are the major concern when operating on alternative gaseous fuels. If any additional sulfur and other components (e.g., chlorides) can be removed prior to entering the fuel processing catalyst, there should be no performance or life impact. If not, the compounds can cause decreased fuel processor catalyst life and potentially impact stack life.

6.4.9 System Availability

Fuel cell systems are generally perceived as low maintenance devices. Fuel cells in North America have been recorded achieving more than 90 percent availability. In premium power applications, 100 percent customer power availability, and 95 percent+ fleet availability has been reported during the same time period. Fuel cells can provide high levels of availability, especially in high load factor (i.e. baseload) applications.

6.5 Emissions and Emissions Control Options

As the primary power generation process in fuel cell systems does not involve combustion, very few emissions are generated. In fact, the fuel processing subsystem is the only source of emissions. The anode-off gas that typically consists of 8 to 15 percent hydrogen is combusted in a catalytic or surface burner element to provide heat to the reforming process. The temperature of this very lean combustion can be maintained at less than 1,800° F, which also prevents the formation of oxides of nitrogen (NO_x) but is sufficiently high to ensure oxidation of carbon monoxide (CO) and volatile organic compounds (VOCs – unburned, non-methane hydrocarbons). Other pollutants such as oxides of sulfur (SO_x) are eliminated because they are typically removed in an absorbed bed before the fuel is processed.

6.5.1 Primary Emissions Species

6.5.1.1 Nitrogen Oxides (NO_x)

NO_x is formed by three mechanisms: thermal NO_x, prompt NO_x, and fuel-bound NO_x. Thermal NO_x is the fixation of atmospheric oxygen and nitrogen, which occurs at high combustion temperatures. Flame temperature and residence time are the primary variables that affect thermal NO_x levels. The rate of thermal NO_x formation increases rapidly with flame temperature. Prompt NO_x is formed from early reactions of nitrogen molecules in the combustion air and hydrocarbon radicals from the fuel. It forms within the flame and typically is on the order of 1 ppm at 15 percent O₂, and is usually much smaller than the thermal NO_x formation. Fuel-bound NO_x forms when the fuel contains nitrogen as part of the hydrocarbon structure. Natural gas has negligible chemically bound fuel nitrogen. Fuel-bound NO_x can be at significant levels with liquid fuels.

6.5.1.2 Carbon Monoxide (CO)

CO and VOCs both result from incomplete combustion. CO emissions result when there is inadequate oxygen or insufficient residence time at high temperature. Cooling at the combustion chamber walls and reaction quenching in the exhaust process also contribute to incomplete combustion and increased CO emissions. Excessively lean conditions can lead to incomplete and unstable combustion and high CO levels.

6.5.1.3 Unburned Hydrocarbons

Volatile hydrocarbons, also called volatile organic compounds (VOCs), can encompass a wide range of compounds, some of which are hazardous air pollutants. These compounds are discharged into the atmosphere when some portion of the fuel remains unburned or just partially burned. Some organics are carried over as unreacted trace constituents of the fuel, while others may be pyrolysis products of the heavier hydrocarbons in the gas. Volatile hydrocarbon emissions from reciprocating engines are normally reported as non-methane hydrocarbons (NMHCs). Methane is not a significant precursor to ozone creation and smog formation and is not currently regulated. Methane is a greenhouse gas and may come under future regulations.

6.5.1.4 Carbon Dioxide (CO₂)

Carbon dioxide (CO₂) emissions are of concern due to its contribution to global warming. Atmospheric warming occurs since solar radiation readily penetrates to the surface of the planet but infrared (thermal) radiation from the surface is absorbed by the CO₂ (and other polyatomic gases such as methane, unburned hydrocarbons, refrigerants and volatile chemicals) in the atmosphere, with resultant increase in temperature of the atmosphere. The amount of CO₂ emitted is a function of both fuel carbon content and system efficiency. The fuel carbon content of natural gas is 34 lbs carbon/MMBtu; oil is 48 lbs carbon/MMBtu; and (ash-free) coal is 66 lbs carbon/MMBtu.

6.5.2 Fuel Cell Emission Characteristics

Table 6-5 illustrates the emission characteristics of fuel cell systems. Fuel cell systems do not require any emissions control devices to meet current and projected regulations. As previously noted, fuel cells generally have very low emissions.

Table 6-5. Estimated Fuel Cell Emission Characteristics without Additional Controls

Emissions Characteristics	System 1	System 2	System 3	System 4	System 5
Fuel Cell Type	PEMFC	SOFC	MCFC	PAFC	MCFC
Nominal Electricity Capacity (kW)	0.7	1.5	300	400	1,400
NO _x (lb/MWh)	Negligible	Negligible	0.01	0.01	0.01
SO _x (lb/MWh)	Negligible	Negligible	0.0001	Negligible	0.0001
CO (lb/MWh)	Negligible	Negligible	Negligible	0.02	Negligible
VOC (lb/MWh)	Negligible	Negligible	Negligible	0.02	Negligible
CO ₂ (lb/MWh)	1,131	734	980	1,049	980
CO ₂ with heat recovery (lb/MWh)	415	555	520-680	495	520

Source: ICF Manufacturer Data Collection

6.6 Future Developments

Over the past years fuel cell capital costs have decreased and their use in multiple applications have increased. In 2007, SOFC were not even commercially shipping and now there are many of them being shipped in multiple sizes globally. In the US multiple factors point towards continued levels of fuel cell market penetration. These factors include: relatively low domestic natural gas prices, continued fuel cell technological advancements reducing capital costs and new business models such as leasing, favorable incentives and policies, continued desire for low emissions profiles, and general resiliency and reliability advantages of distributed energy.

Globally, MCFC shipments by MW have been on par with that of vehicle PEMFC, as shown in **Figure 6-5**. As the only commercial developer of MCFCs in the United States, Fuel Cell Energy is uniquely positioned to continue its successes, both domestically and internationally.

Figure 6-5. Recent Worldwide Fuel Cell Installations by Fuel Cell Type, in Megawatts

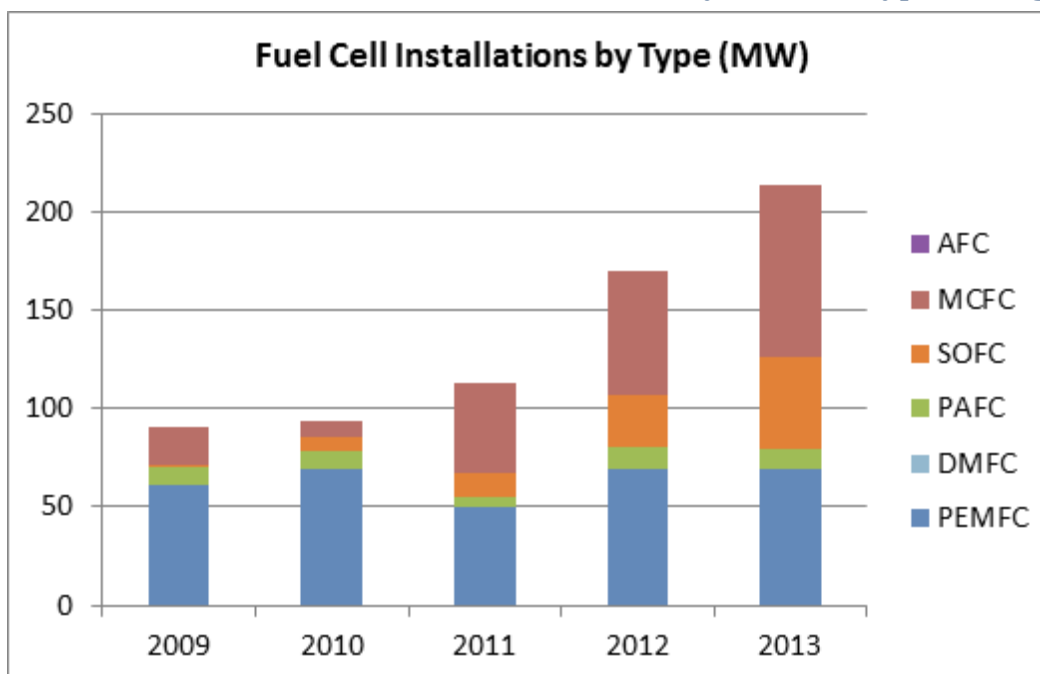

Source: Fuel Cell Today¹⁰¹

Large-scale stationary fuel cells for CHP have also been successfully deployed in Asia (specifically Korea and Japan). Europe could also be a growth opportunity as FuelCell Energy has formed joint ventures in the European continent.¹⁰² It is likely through these international joint ventures that US-based fuel cell manufacturers can leverage local market experience and technological expertise in international markets. These sales opportunities will also increase demand leading to potentially more reductions in costs as we have seen in solar photovoltaic panels and now batteries.

¹⁰¹ "The Fuel Cell Industry Review 2013", Fuel Cell Today. http://www.fuelcelltoday.com/media/1889744/fct_review_2013.pdf

¹⁰² "FuelCell Energy Announces Completion of Asset Acquisition and German Joint Venture with Fraunhofer IKTS", June 26, 2012. <http://fcel.client.shareholder.com/releasedetail.cfm?releaseid=686425>

What may be the next significant growth engine for fuel cells is the development of micro-CHP fuel cells. According to a 2013 report from Fuel Cell Today, residential micro-CHP fuel cells outsold conventional micro-CHP boilers for the first time in 2012 in Japan. The report elaborates that this micro-CHP application is migrating to Europe and it may become a trend in the US with both PEMFC and SOFC technologies.

Section 7. Packaged CHP Systems

Acknowledgements

This section of the Catalog was prepared by David Jones (ICF International), Anne Hampson (ICF International), Charlie Goff (ERG), Gary McNeil (U.S. Environmental Protection Agency), and Neeharika Naik-Dhungel (U.S. Environmental Protection Agency).

7.1 Introduction

The purpose of this section of the Catalog is to introduce packaged CHP systems and their unique attributes to facility owners and operators, real estate developers, CHP project developers, architects, engineers, and policymakers.

Depending on the application, packaged systems can be cheaper and easier to install and operate than conventional CHP systems (i.e., unique site-specific systems involving the integration of different components — prime mover, generator, heat recovery equipment, electrical switchgear, emissions control devices, and controls). Also, because packaged systems are standardized, they can be good choices for organizations with multiple facilities with similar electrical and thermal requirements.

This section of the Catalog of CHP Technologies is different than the other sections of the Catalog, in that it addresses a new CHP system configuration, whereas the other sections characterize specific CHP prime mover technologies. Accordingly, this section includes material such as installations and technical potential by market segment, which are not found in the other sections.

Packaged systems include a prime mover (i.e., reciprocating engine, microturbine, or fuel cell), a generator, heat recovery equipment, electrical switchgear, emissions control devices, and controls, sometimes packaged in a weather-resistant sound-attenuating enclosure. These systems can be installed as single units or combined to form larger systems. Product offerings for packaged systems have been focused on relatively small (≤ 500 kW) sizes.

This section of the Catalog provides an overview of packaged systems, including:

- The evolution of packaged CHP systems
- Significant attributes
- Applications
- Technology description
- Cost and performance characteristics
- Emissions and emissions control options

7.2 The Evolution of Packaged CHP Systems

Until relatively recently, nearly all CHP installations were unique site-specific conventional CHP systems. In the late 1990s, as the market for CHP applications boomed, many manufacturers and developers started offering standardized factory-built, ready-to-install packaged CHP systems that simplified, and

shortened the time required for, CHP system procurement and installation. Today there are 27 packaged system vendors in the United States, according to a 2016 survey¹⁰³ of the packaged CHP industry.

In 2016 an estimated 950 packaged systems are installed in the United States, totaling 215 MW of capacity.¹⁰⁴ Annual additions of packaged system capacity are increasing, as shown in **Figure 7-1**.¹⁰⁵

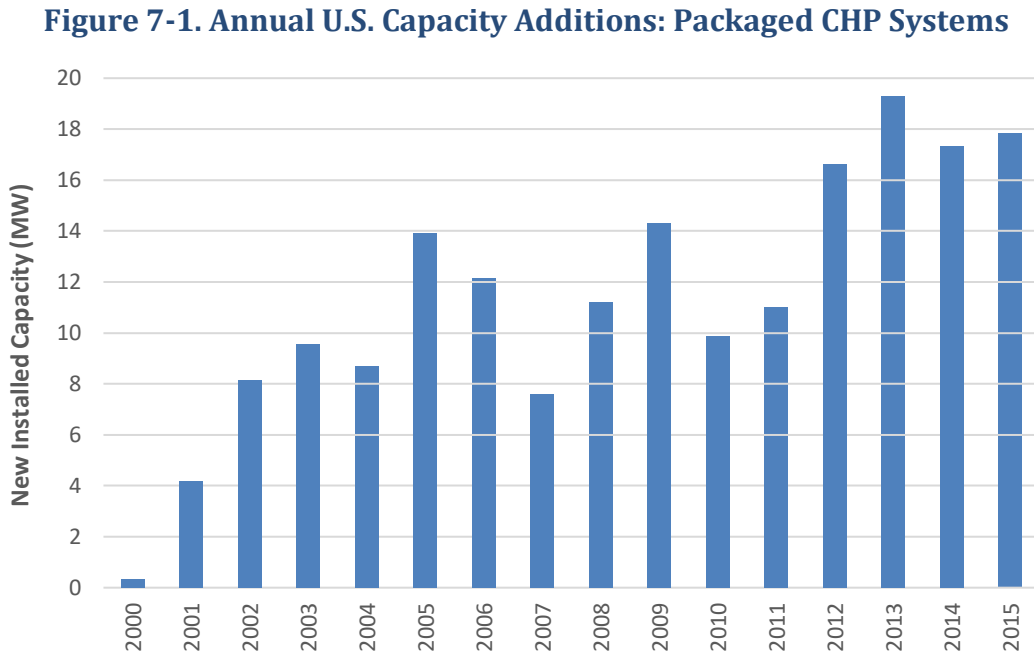

Source: ICF/U.S. DOE Combined Heat and Power Installation Database, February 2017, <https://doe.icfwebservices.com/chpdb/>.

¹⁰³ Compiled by ICF from vendor-supplied data, 2016.

¹⁰⁴ ICF/U.S. DOE Combined Heat and Power Installation Database, February 2017, <https://doe.icfwebservices.com/chpdb/>.

¹⁰⁵ Ibid.

Examples of Packaged CHP Systems

Figure 7-2. Aegis ThermoPower (TP-75), 75 kW



Figure 7-3. Tecogen Tecopower CM-75, 75 kW



Figure 7-4. MTU 12V400 GS, 358 kW



Figure 7-5. Capstone C65 ICHP, 65 kW



Figure 7-6. Amerigen 8150 (Using the MAN E2876 E312 Engine), 150 kW



Figure 7-7. Energy Choice EC 190 Natural Gas system, 190 kW



Figure 7-8. 2G Avus 800, 800 kW



Figure 7-9. Siemens SGE-36SL, 676 kW



7.3 Significant Attributes

Packaged systems have certain important attributes:

- Standardization
- Black start/islanding capability (sometimes optional)
- Acoustic enclosure (sometimes optional)
- Modularity
- Third-party own/operate business arrangements (may be available)
- Replicability

7.3.1 Standardization

Because packaged systems are built and delivered in accordance with published specifications, their configuration and performance can be well understood before the purchase decision is made. This facilitates many elements of the procurement process, including equipment selection, financial analysis before purchase, site-specific engineering, permitting and site modifications, as well as system installation. Site-specific engineering is typically limited to designing connections to the fuel supply, water supply, thermal loads, electrical system, and building control system.

Customers can choose several options. These include:

- Type of generator (synchronous, induction, or inverter)
- Black start/islanding capability
- Enhanced sound attenuation
- Additional emissions controls
- Specialized heat recovery options, such as an absorption chiller to produce chilled water for cooling applications or a steam boiler to make steam from the prime mover exhaust

NYSERDA CHP Program

The standardization of CHP equipment can make it easier for programs such as the New York State Energy Research and Development Authority's (NYSERDA's) CHP Program to pre-approve projects for incentives. Programs like NYSERDA's provide a level of assurance that the pre-approved systems meet the requirements of the approving organization.

Information about NYSERDA's CHP Program is available at:

https://portal.nysERDA.ny.gov/CORE_Solicitation_Detail_Page?SolicitationId=a0rt0000000QnqyAAC

7.3.2 Black Start/Islanding Capability

Several packaged system vendors offer models with black start/islanding capability. These systems can disconnect from the utility grid using an automatic transfer switch and run independently during power outages (i.e., in "island mode"). While CHP systems are not typically intended to meet a facility's full load requirements, they can provide electricity to critical loads when the electric grid is not available.

CHP systems with black start/islanding capability can supplement traditional diesel standby generators, providing an added level of redundancy during long-term outages and natural disasters when diesel fuel

can become scarce (e.g., Hurricane Sandy). Also, in certain circumstances, CHP can replace diesel standby generators.

Black start/islanding capability requires additional components, which may increase equipment cost and/or installation cost. The extent to which black start/islanding capability adds to installation costs depends on factors such as the existing electrical system in the host facility, the switchgear required, and the size of the electrical loads to be served when the system is islanding.¹⁰⁶

7.3.3 Acoustic Enclosure

Systems may include a sound attenuation enclosure—as standard equipment or as an option—consisting of sound-absorbing material surrounded by a metal cover. Optional enhanced sound attenuation capability may be available.

7.3.4 Modularity

Because of their modular design, packaged systems can be installed as single units, or several can be connected to create larger multiple-unit systems. Systems using multiple modular units can have a number of additional significant attributes:

- Under certain circumstances, multiple-unit systems can be more efficient than a conventional CHP system of the same size. Conventional systems lose efficiency when slowed down to follow load fluctuations. In multiple-unit systems, individual units can be shut down to reduce system output to follow load fluctuations, allowing remaining operational units to function at higher efficiencies.
- Systems using multiple modular units can also improve reliability and system availability, since one unit can be taken off line for maintenance while the others continue to operate.
- Additional units can be added over time to increase output as electrical and/or thermal loads increase.¹⁰⁷

CHP Project Development

Taking a CHP project from conception to completion involves five steps:

- Qualification/screening
- Level 1 feasibility analysis
- Level 2 feasibility analysis (investment grade analysis)
- Procurement, including installation
- Operations and maintenance

Depending on the nature of the facility and the performance objectives of a CHP system being considered, each of the five steps may be performed by the facility's manager or agent, consultants, or vendors.

Learn more about these steps, including goals, timeframes, typical costs, and facility level of effort required on the [EPA CHP Partnership website](#).

A disadvantage of using multiple modular units instead of one large unit is that the installed cost per kW is typically higher. In addition, in full-load operation, a conventional CHP system will typically be more efficient than a system of equal size comprising multiple packaged system units.

¹⁰⁶ Based on data collected from EPA CHP Partners that manufacture packaged CHP systems.

¹⁰⁷ Often up to five or six units may be operated together, depending on the equipment specifications.

7.3.5 Third-Party Own/Operate Business Arrangements

Many packaged system vendors offer “own and operate” business arrangements, which can be structured as agreed upon by the host facility and the vendor. One model is for the vendor or a third party to install, own, operate, and maintain the system, and provide the system outputs to the host facility under terms established in a contract. In this way, the facility can have on-site power production and other CHP benefits without a capital expenditure or the risks and responsibilities of ownership. The contract may include an option for the host facility to purchase the system at specified terms.

7.3.6 Replicability

Operators of multifamily buildings, big box stores, hotels, restaurants, and supermarkets often manage many buildings with similar electrical and thermal requirements. Because a specific packaged system model will perform consistently when installed in facilities with comparable layouts and electric/thermal requirements, that model can become a known quantity for the building operator. With this experience, the building operator can confidently choose the same system for other buildings with similar electrical/thermal requirements.

7.4 Applications

While conventional CHP applications have been concentrated in the industrial/heavy manufacturing sector, packaged CHP applications are most often used in the commercial, multifamily, institutional, and light manufacturing sectors. Attributes of facilities that make them good matches for packaged systems include:

- **Electrical and thermal load and profiles that match packaged system outputs.** Most packaged systems are under 500 kW in size, which is a good match for the electrical and thermal loads of commercial, multifamily, and institutional buildings.
- **Space constraints** – Many facilities have constraints on the physical size of units that can be installed, and packaged systems tend to have a relatively small footprint.
- **Building owners who place a high value on ease of installation and operation** – The standardization of packaged systems means an easier procurement process compared to conventional CHP systems.
- **Need for flexible financing options** – CHP projects are capital-intensive, which can be a problem for some market sectors. Many packaged systems are available through “own and operate” arrangements, where the vendor retains ownership and is responsible for installation, operation, and maintenance, if the building owners do not want to perform this function.
- **A building that is one of several similar facilities in the same enterprise** – If a packaged system is a good fit for one facility, it becomes a known quantity that can be confidently deployed at other facilities with similar load requirements and layouts.

Larger energy users, such as industrial/manufacturing facilities and some large institutional facilities might not find as much value in a packaged system as they would in a custom-engineered conventional CHP system that can be precisely tailored to their specific facility needs.

7.4.1 Installed Packaged Systems

Figure 7-10 presents packaged system installations by market segment, and Table 7-1 presents total installed packaged system capacity and the median system size by market segment.

Figure 7-10. Packaged System Installations by Market Segment

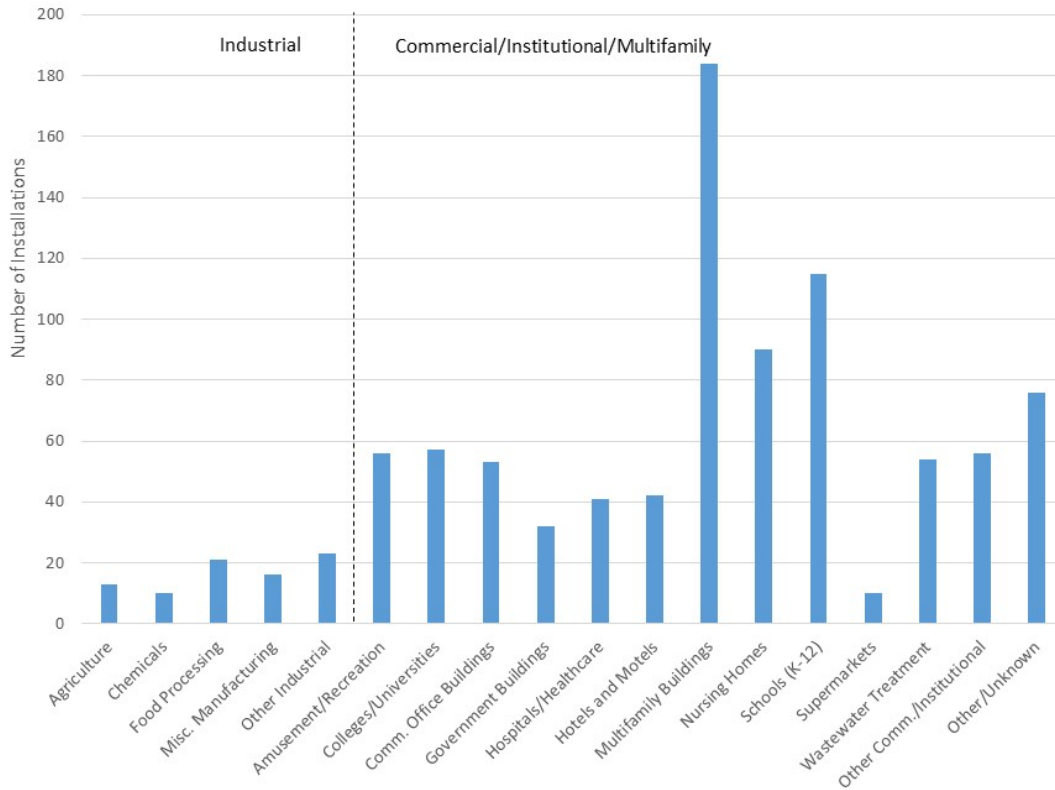

Source: ICF/U.S. DOE Combined Heat and Power Installation Database, February 2017
<https://doe.icfwebservices.com/chpdb/>.

Table 7-1. Packaged Systems Total Installed Capacity and Median Size by Market Segment

Sector	Market Segment	Installed Capacity (MW)	Median Size (kW)
Industrial	Agriculture	4.5	100
	Chemicals	5.0	180
	Food Processing	10.9	300
	Misc. Manufacturing	8.0	390
	Other Industrial	9.8	180
Commercial Institutional Multifamily	Amusement/Recreation	7.6	75
	Colleges/Universities	14.5	180
	Commercial Office Buildings	21.4	75
	Government Buildings	6.4	90
	Hospitals/Healthcare	15.7	220
	Hotels and Motels	7.8	100
	Multifamily Buildings	22.3	75
	Nursing Homes	10.8	75
	Schools (K-12)	17.7	75
	Supermarkets	4.2	320
	Wastewater Treatment	14.1	130
	Other Comm./Institutional	16.3	170
	Other/Unknown	18.6	140

Source: ICF/U.S. DOE Combined Heat and Power Installation Database, February 2017
<https://doe.icfwebservices.com/chpdb/>.

The packaged system market has been dominated by market segments in the commercial/institutional/multifamily sector. More than 91 percent of installations are contained in these sectors. Multifamily buildings have the highest number of packaged system installations, followed by schools and nursing homes. These market segments, as well as hotels, government buildings, and amusement and recreation facilities, tend to use smaller systems, with median sizes of 100 kW or less, than the other market segments. Industrial market segments have fewer installations but tend to have larger capacities, with median sizes greater than 100 kW.

Figure 7-11 presents packaged system installations and capacity by size range. Almost 90 percent of the packaged system installations are applications under 500 kW in size (although packaged system are available in sizes up to several MW). Note that the total installed capacity of systems under 500 kW is approximately equal to that of systems > 500 kW.

Figure 7-11. Packaged System Installations and Capacity by Size Range

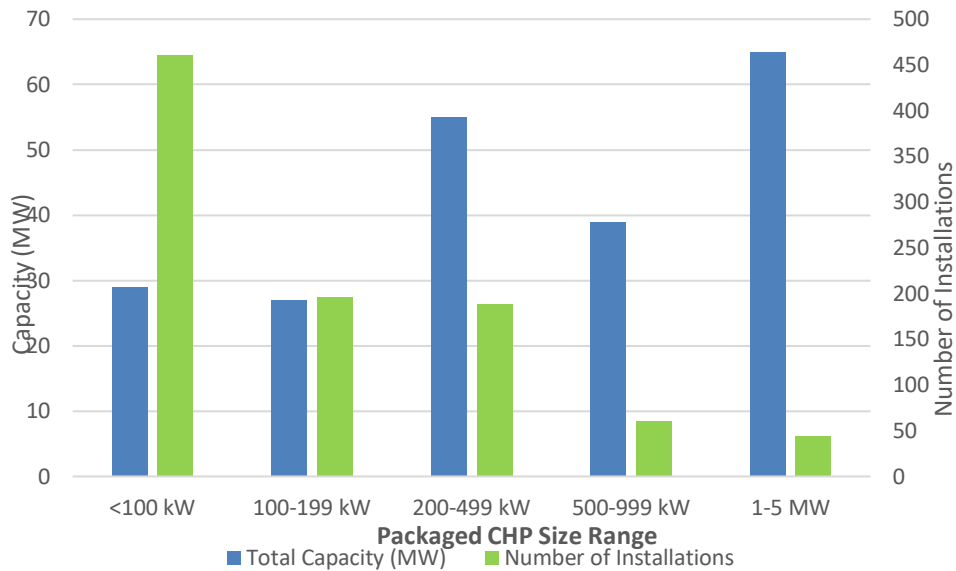

Source: ICF/U.S. DOE Combined Heat and Power Installation Database, February 2017, <https://doe.icfwebservices.com/chpdb/>.

7.4.2 Technical Potential

Technical potential is an estimate of market size constrained only by technological limits—the ability of CHP technologies to fit customer energy needs without regard to economic or market factors. For this reason, actual potential will be less than technical potential, but in some cases, it may still be a useful indicator of relative economic potential.

Ninety percent of packaged system installations are units under 500 kW. There is currently 21.3 GW of technical potential for systems under 500 kW in the U.S. commercial, institutional, and multifamily sectors¹⁰⁸, at more than 100,000 facilities. The technical potential for <500 kW packaged system applications is greatest in the following ten market segments:

- Amusement/recreation
- Big box retail
- Commercial office buildings
- Government buildings
- Hotels and motels
- Multifamily buildings
- Nursing homes
- Restaurants
- Schools
- Supermarkets

¹⁰⁸ ICF, CHP Technical Potential Database, 2016.

Each of these market segments is estimated to contain over 1 GW of technical potential for systems <500 kW. **Figure 7-12** breaks down the technical potential for packaged systems <500 kW.

Figure 7-12. Technical Potential for <500 kW Packaged CHP Applications in the Commercial and Institutional Sectors, by Market Segment

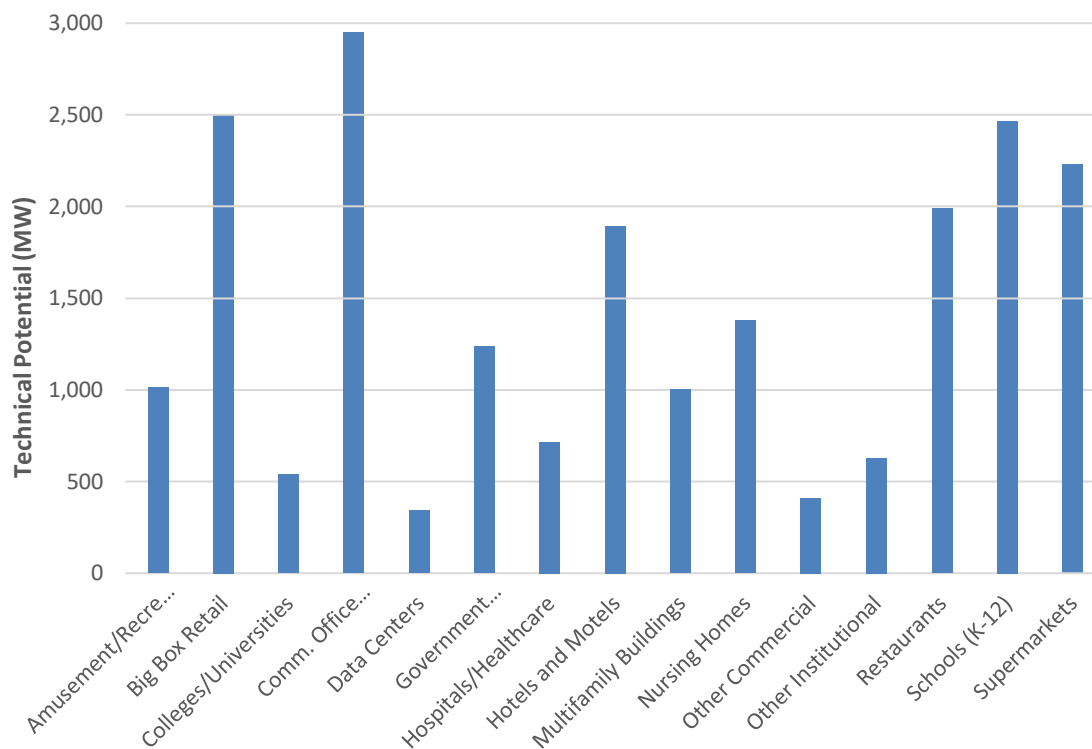

Source: ICF, 2016.

More information on the technical potential for CHP applications – including the industrial sector and larger size ranges – can be found in the Department of Energy’s 2016 CHP Technical Potential Report.¹⁰⁹

7.5 Technology Description

The general design of packaged systems is relatively consistent throughout all packaged products. The main components of packaged systems include:

- **Prime mover** – the power-producing machine (or chemical process, in the case of fuel cells) that drives the electric generator.
- **Generator** – a device that converts mechanical energy into electricity.
- **Heat exchanger** – a device that transfers heat from the prime mover exhaust gas and/or the engine block to water, to produce hot water or steam.

¹⁰⁹ U.S. Department of Energy, *Combined Heat and Power (CHP) Technical Potential in the United States*, March 2016, <http://energy.gov/sites/prod/files/2016/04/f30/CHP%20Technical%20Potential%20Study%203-31-2016%20Final.pdf>.

- **Control panel** – controls and monitoring instruments.

Figure 7-13 provides a process diagram that shows how these different components interact in a packaged system.

Figure 7-13. Packaged CHP System Diagram

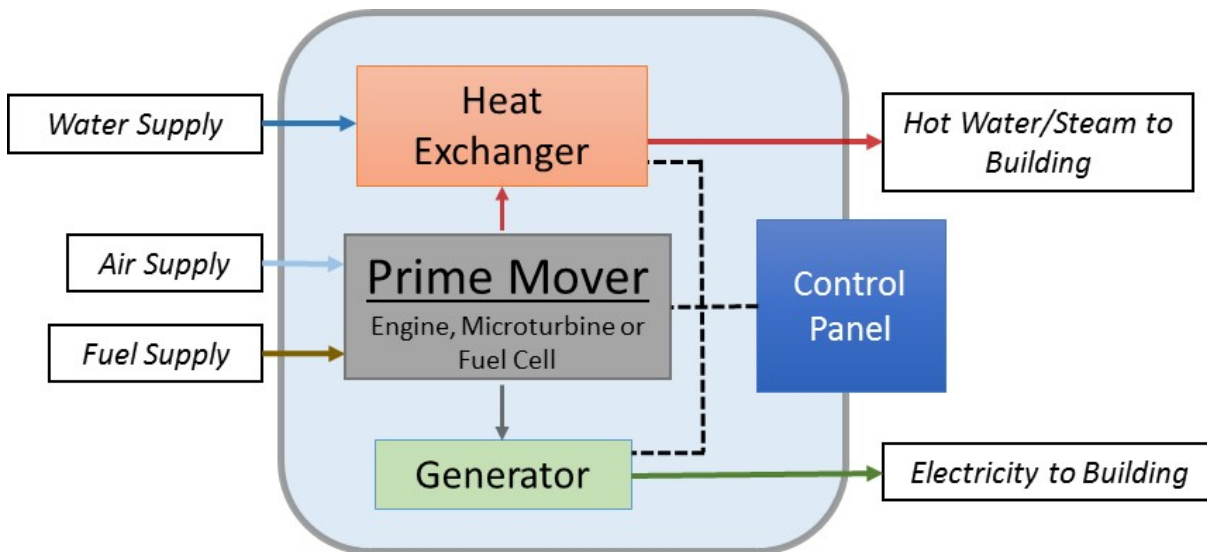

Source: EPA CHP Partnership

7.5.1 Heat Recovery

A defining characteristic of CHP systems is their ability to recover and put to beneficial use otherwise-wasted heat. Most packaged systems use recovered heat to produce hot water, but steam and chilled water options are also available.

To produce chilled water, packaged systems are coupled with an absorption chiller, which converts recovered heat into chilled water that can be used for air conditioning or other cooling loads. In this way, more of the system’s thermal output can be used, which increases system efficiency. Packaged systems with absorption chillers are well-suited for applications that consistently require chilled water, such as supermarkets and data centers, as well as buildings with seasonal heating and cooling needs, like multifamily buildings, hotels, health clubs and health care facilities.

Specifying Packaged CHP System Capacity Based on Thermal and Electric Requirements

Sizing decisions are best made based on an understanding of facility electrical and thermal loads (hot water, heating cooling), and how they match with the outputs of available packaged systems. Typically, packaged CHP capacity is selected in a way that allows facilities to utilize all of the electric and thermal energy on site, while operating at or near full load. Building energy modeling can be used to determine the system that best meets the facility’s needs while operating efficiently and providing an acceptable return on investment. Energy models often used include eQUEST and EnergyPlus.

7.6 Cost and Performance Characteristics

When making a purchase decision, the cost and performance characteristics presented in this section should be considered in conjunction with other factors, such as expected service life, guarantees, and availability of service and support, along with performance characteristics not presented here, such as noise and vibration.

Table 7-2 summarizes the performance characteristics for packaged systems consisting of a single reciprocating engine or microturbine. Data were gathered from the seven EPA CHP Partner companies that manufacture packaged systems and that responded to a data request.¹¹⁰

Fuel Cells: Efficient Operation and Environmental Benefits

Fuel cell CHP systems can be designed to operate with high electric efficiencies—potentially over 50 percent—and can maintain high efficiency at partial loads. Most fuel cells convert natural gas to hydrogen using a reformer, which emits carbon at a lower rate than other prime mover technologies. Nearly all fuel cell CHP is sold as packaged systems.

Table 7-2. Packaged CHP Systems – Performance Characteristics

Performance Characteristic	Size Range (kW) ¹¹¹				
	30-99	100-199	200-499	500-1,000	>1,000
Electrical Heat Rate (Btu/kWh), HHV	10,000 - 12,600	9,800 - 12,600	9,200 - 10,800	9,000 - 11,000	8,200 - 10,400
Electrical Efficiency (%), HHV	24-32%	27-35%	32-37%	28-38%	33-41%
Total Heat Recovered (Btu/kWh)	5,300 - 7,000	4,600 - 6,400	3,600 - 5,400	3,600 - 4,700	3,400 - 5,600
Typical form of Recovered Heat ¹¹²	H ₂ O	H ₂ O	H ₂ O	H ₂ O	H ₂ O, Steam
Total CHP Efficiency ¹¹³ (%), HHV	73-82% ¹¹⁴	67-86%	76-82%	67-82%	78-87%
Power/Heat Ratio	0.49-0.64	0.52-0.73	0.64-0.95	0.72-0.96	0.61-1.01

Source: Compiled from data supplied by the seven EPA CHP Partner companies that manufacture packaged systems and that responded to a data request.

¹¹⁰ These seven companies manufacture systems using reciprocating engines or microturbines, which account for 97 percent of packaged systems in the United States (fuel cell systems account for the remaining three percent). One additional company, which manufactures packaged systems using fuel cells, responded to the data request. However, because fuel cells have different characteristics, and tend to be used in different applications than reciprocating engine and microturbine systems, they are not a focus of this section. Fuel cell cost and performance characteristics can be found in the Fuel Cells section of the Catalog.

¹¹¹ Size ranges reflect the large majority of packaged systems sold. However, some vendors sell systems as small as 5 kW.

¹¹² Although hot water is the typical form of recovered heat for most size ranges, steam may be an option for all ranges.

¹¹³ Total CHP efficiency for reciprocating engines is approximately 80 percent, while the total CHP efficiency for microturbines tends to be close to 70 percent.

¹¹⁴ One vendor reports offering a 50 kW system with 92 percent efficiency. The system has unique attributes and certain limitations compared to typical systems.

Some key takeaways from **Table 7-2** are:

- Electric efficiencies and total CHP efficiencies tend to increase with system size.
- As systems get larger, the power-to-heat ratio tends to increase (i.e., more electricity is delivered relative to recovered heat).
- Performance varies within a given size range due to different prime mover and heat recovery technologies, and different system designs.
- Recovered heat from packaged systems is typically in the form of hot water.

More details on the characteristics of efficiency, thermal output, and other technical information for reciprocating engines and microturbine technologies are provided in their respective Catalog sections.

7.6.1 Part-Load Operation

In most packaged systems, reciprocating engines or microturbines drive generators at a constant speed to produce steady alternating current (AC) power. As load is reduced, generator speed decreases, the heat rate of the prime mover increases, and electrical efficiency decreases. Electrical efficiency at half load is typically 10 to 25 percent less than full-load efficiency, with efficiencies falling more steeply for loads lower than half of the unit's rated capacity.

Systems comprising multiple units can reduce part-load efficiency penalties, which is especially important for commercial applications. Electric loads for commercial buildings tend to vary more than they do in manufacturing facilities. Because individual units can be put in standby mode when the building load drops, the other units can continue to operate at or near peak efficiency. In the same circumstances, a single-unit system might need to operate at reduced electrical efficiency.

More information on part-load performance for reciprocating engines and microturbines can be found in their respective sections of the Catalog.

7.6.2 Installed Costs

Installed costs include equipment and installation costs. Equipment costs vary depending on factors such as:

- Emissions controls (included as standard equipment or as options)
- Sound attenuation performance level
- Generator type (induction/synchronous/inverter)
- Black start/islanding capability
- Specialized heat recovery equipment (e.g. absorption chiller)

Table 7-3 presents typical equipment costs for packaged systems. These costs represent cost data provided by EPA CHP Partner companies that manufacture packaged systems and reflect difference in features provided as standard equipment.

Installation costs are not presented. Packaged system vendors report large variations in installation costs, based on such factors as:

- Variables based on the location of the equipment, such as ventilation routing, or rigging or cranes that might be required for installation. Also, installation costs may be higher for retrofits of existing buildings compared to new construction.
- Insurance requirements for contractors and subcontractors.
- Bonding requirements.
- Restrictions on working hours and access to site.
- Metering, permitting, and utility interconnection requirements.
- Local labor rates or minimum rates required by the Davis-Bacon and Related Acts, where applicable.
- Black start/islanding capability, which adds to installation costs depending on factors such as the existing electrical system in the host facility, switchgear required, and the size of the electrical loads to be served when the system is islanding.

Installation costs for packaged systems tend to be less than for conventional systems of similar size. For example, for a 1,000 kW packaged system, installation costs can be as low as \$150,000 compared to \$700,000 for conventional systems.

Table 7-3. Packaged CHP Systems – Equipment Costs

Packaged System Costs	Size Range (kW)				
	30-99	100-199	200-499	500-1,000	>1,000
Equipment Cost (\$/kW)	\$1,000 - \$2,850	\$1,400 - \$3,100	\$1,000 - \$2,000	\$900 - \$1,850	\$650 - \$1,100

Source: Compiled from data supplied by the seven EPA CHP Partner companies that manufacture packaged systems and that responded to a data request.

7.6.3 Maintenance Costs

Unlike for conventional systems, maintenance for packaged systems is typically performed by the system vendor or a third party. Maintenance costs vary depending on factors such as type of CHP technology, remote monitoring, and performance guarantees. The ranges of maintenance costs for different sizes of packaged system reciprocating engines and microturbines are shown in **Table 7-4** (while costs here are presented in \$/kWh, note that some vendors price maintenance in \$/run hour, not \$/kWh). For more information on maintenance requirements for reciprocating engines and microturbines, refer to their respective sections of the Catalog.

Table 7-4. Packaged CHP Systems – Maintenance Costs

	Size Range (kW)				
	30-99	100-199	200-499	500-1,000	>1,000
Maintenance Costs (\$/kWh)	\$0.013 - \$0.025	\$0.018 - \$0.025	\$0.017 - \$0.021	\$0.010 - \$0.016	\$0.002 - \$0.016

Source: Compiled from data supplied by the seven EPA CHP Partner companies that manufacture packaged systems and that responded to a data request. vendors.

7.6.4 Fuels

Packaged systems generally use natural gas as fuel. However, other fuels, such as propane and biogas, can be used. Biogas fuels (e.g., anaerobic digester gas and landfill gas) may require pretreatment to remove moisture, hydrogen sulfide and siloxanes. The extent of pretreatment depends on the quality of the fuel and the prime mover technology. More details on fuels that can be used for different prime movers can be found in their respective technology characterizations in the Catalog.

7.7 Emissions, Emissions Control Options, and Prime Mover Certification

Most CHP systems emit certain pollutants—carbon dioxide¹¹⁵, oxides of nitrogen (NO_x), carbon monoxide (CO), and volatile organic compounds. Emissions can vary depending on the prime mover technology, fuel type, and the emissions controls that are applied. Many packaged systems are equipped with emissions controls to reduce NO_x, CO and VOC emissions. Additional emissions controls may be available as options.

Packaged system vendors may offer systems with engines certified to comply with U.S. EPA regulations for stationary engines. A certificate of conformity with the Clean Air Act is supplied with these engines. Owners of systems with non-certified engines are responsible for having the engines individually performance-tested using the required EPA-approved test protocol (some vendors who sell uncertified systems perform emissions testing on systems after they are installed).

A thorough discussion of emissions and control options for each prime mover technology is provided in its respective technology characterization sections of the Catalog.

¹¹⁵ While there is no currently viable technology to reduce CO₂ emissions from fossil fuel combustion, emissions can be reduced by increasing the useful outputs from a given amount of fuel burned. CHP is a highly cost-effective way to achieve this objective.

Appendix A: Expressing CHP Efficiency

Appendix A: Expressing CHP Efficiency

A.1 Expressing CHP Efficiency

Many of the benefits of CHP stem from the relatively high efficiency of CHP systems compared to other systems. Because CHP systems simultaneously produce electricity and useful thermal energy, CHP efficiency is measured and expressed in a number of different ways¹¹⁶ **Table A-I** summarizes the key elements of efficiency as applied to CHP systems.

As illustrated in **Table A-I** the efficiency of electricity generation in power-only systems is determined by the relationship between net electrical output and the amount of fuel used for the power generation. **Heat rate**, the term often used to express efficiency in such power generation systems, is represented in terms of Btus of fuel consumed per kWh of electricity generated. However, CHP plants produce useable heat as well as electricity. In CHP systems, the **total CHP efficiency** seeks to capture the energy content of both electricity and usable steam and is the net electrical output plus the net useful thermal output of the CHP system divided by the fuel consumed in the production of electricity and steam. While total CHP efficiency provides a measure for capturing the energy content of electricity and steam produced it does not adequately reflect the fact that electricity and steam have different qualities. The quality and value of electrical output is higher relative to heat output and is evidenced by the fact that electricity can be transmitted over long distances and can be converted to other forms of energy. To account for these differences in quality, the Public Utilities Regulatory Policies Act of 1978 (PURPA) discounts half of the thermal energy in its calculation of the efficiency standard (EFF_{FERC}). The EFF_{FERC} is represented as the ratio of net electric output plus half of the net thermal output to the total fuel used in the CHP system. Opinions vary as to whether the standard was arbitrarily set, but the FERC methodology does recognize the value of different forms of energy. The following equation calculates the FERC efficiency value for CHP applications.

$$EFF_{FERC} = \frac{P + Q/2}{F}$$

Another definition of CHP efficiency is **effective electrical efficiency**, also known as **fuel utilization effectiveness (FUE)**. This measure expresses CHP efficiency as the ratio of net electrical output to net fuel consumption, where net fuel consumption excludes the portion of fuel that goes to producing useful heat output. The fuel used to produce useful heat is calculated assuming typical boiler efficiency, generally 80 percent. The effective electrical efficiency measure for CHP captures the value of both the electrical and thermal outputs of CHP plants. The following equation calculates FEU.

$$FUE = \frac{P}{F - Q/EFF_Q}$$

¹¹⁶ Measures of efficiency are denoted either as lower heating value (LHV) or higher heating value (HHV). HHV includes the heat of condensation of the water vapor in the products. Unless otherwise noted, all efficiency measures in this section are reported on an HHV basis.

FUE captures the value of both the electrical and thermal outputs of CHP plants and it specifically measures the efficiency of generating power through the incremental fuel consumption of the CHP system.

EPA considers fuel savings as the appropriate term to use when discussing CHP benefits relative to separate heat and power (SHP) operations. Fuel savings compares the fuel used by the CHP system to a separate heat and power system (i.e. boiler and electric-only generation). The following equation determines percent fuel savings (S).

$$S = 1 - \left[\frac{F}{\frac{P}{\text{Eff}_p} + \frac{Q}{\text{Eff}_q}} \right]$$

In the fuel saving equation given above, the numerator in the bracket term denotes the fuel used in the production of electricity and steam in a CHP system. The denominator describes the sum of the fuel used in the production of electricity (P/Eff_p) and thermal energy (Q/Eff_q) in separate heat-and-power operations. Positive values represent fuel savings while negative values indicate that the CHP system in question is using more fuel than separate heat and power generation.

Table A-1. Measuring the Efficiency of CHP Systems

System	Component	Efficiency Measure	Description
Separate heat and power (SHP)	Thermal Efficiency (Boiler)	$\text{EFF}_Q = \frac{\text{Net Useful Thermal Output}}{\text{Energy Input}}$	Net useful thermal output for the fuel consumed.
	Electric-only generation	$\text{EFF}_P = \frac{\text{Power Output}}{\text{Energy Input}}$	Electricity Purchased From Central Stations via Transmission Grid.
	Overall Efficiency of separate heat and power (SHP)	$\text{EFF}_{\text{SHP}} = \frac{P + Q}{P/\text{EFF}_{\text{Power}} + Q/\text{EFF}_{\text{Thermal}}}$	Sum of net power (P) and useful thermal energy output (Q) divided by the sum of fuel consumed to produce each.
Combined heat and power (CHP)	Total CHP System Efficiency	$\text{EFF}_{\text{Total}} = (P + Q)/F$	Sum of the net power and net useful thermal output divided by the total fuel (F) consumed.
	FERC Efficiency Standard	$\text{EFF}_{\text{FERC}} = \frac{(P + Q/2)}{F}$	Developed for the Public Utilities Regulatory Act of 1978, the FERC methodology attempts to recognize the quality of electrical output relative to thermal output.

Table A-1. Measuring the Efficiency of CHP Systems

System	Component	Efficiency Measure	Description
	Effective Electrical Efficiency (or Fuel Utilization Efficiency, FUE):	$FUE = \frac{P}{F - Q/EFF_{Thermal}}$	Ratio of net power output to net fuel consumption, where net fuel consumption excludes the portion of fuel used for producing useful heat output. Fuel used to produce useful heat is calculated assuming typical boiler efficiency, usually 80 percent.
	Percent Fuel Savings	$S = 1 - \frac{F}{P/EFF_p + Q/EFF_Q}$	Fuel savings compares the fuel used by the CHP system to a separate heat and power system. Positive values represent fuel savings while negative values indicate that the CHP system is using more fuel than SHP.

Key:

P = Net power output from CHP system

Q = Net useful thermal energy from CHP system

F = Total fuel input to CHP system

EFF_p = Efficiency of displaced electric generation

EFF_Q = Efficiency of displaced thermal generation